

Table of Contents

APPENDIX C

C.1	INTRODUCTION	AC-2
C.2	Erosion Control Best Management Practices (BMPs)	AC-3
C.2.1	Interceptor Swale	AC-7
C.2.2	Diversion Dikes	AC-8
C.2.3	Pipe Slope Drain	AC-9
C.2.4	Channel Stabilization	AC-11
C.2.5	Outlet Stabilization	AC-14
C.2.6	Level Spreaders	AC-17
C.2.7	Subsurface Drains.....	AC-21
C.2.8	Vegetation	AC-26
C.2.9	Mulch	AC-30
C.2.10	Blankets and Matting.....	AC-30
C.2.11	Organic Compost Mulch.....	AC-35
C.2.12	Hydraulic Mulch.....	AC-38
C.2.13	Sod	AC-39
C.2.14	Dust Control	AC-42
C.3	Sediment Control Best Management Practices (BMPs)	AC-43
C.3.1	General Guidelines	AC-43
C.3.2	Temporary Construction Entrance/Exit	AC-46
C.3.3	Silt Fence	AC-48
C.3.4	Triangular Sediment Filter Dikes	AC-51
C.3.5	Tire Washing Facility	AC-53
C.3.6	Rock Berms	AC-55
C.3.7	High Service Rock Berms	AC-57
C.3.8	Brush Berms	AC-60
C.3.9	Check Dams	AC-64
C.3.10	Vegetative Buffers.....	AC-67
C.3.11	Inlet Protection	AC-68
C.3.12	Stone Outlet Sediment Trap	AC-72
C.3.13	Sediment Basins	AC-75
C.3.14	Erosion Control Logs	AC-78
C.3.15	Dewatering Operations	AC-81
C.3.16	Spill Prevention and Control.....	AC-85
C.3.17	Creek Crossings.....	AC-89
C.3.18	Concrete Washout Areas	AC-95

APPENDIX C - Erosion and Sediment Control Best Management Practices

C.1 Introduction

The purpose of this appendix is to provide a resource for the design, installation, inspection, and maintenance of the most commonly used erosion and sediment control Best Management Practices (BMP's). Each BMP is presented with a list of guidelines for proper implementation and a compilation of common trouble points.

Contractors shall install and maintain erosion and sedimentation controls in a careful and proper manner. Minor adjustments should be anticipated to assure proper performance. Intensive maintenance and extensive use of vegetation, mulch, and other ground covers may be required to achieve optimum performance. When erosion and sediment controls are removed after final stabilization of the site, it is important to also remove or stabilize any accumulated sediment.

Periodic inspection and maintenance is vital to the performance of erosion and sedimentation control measures. All temporary erosion and sedimentation controls shall be inspected weekly and after every rainfall or adverse weather event; however, daily inspections may be warranted when environmentally sensitive features are located on or immediately adjacent to the site and when adverse weather events are forecasted. If not properly maintained, some practices may cause more damage than they prevent.

This appendix includes guidance for minimum design criteria for sizing BMP's once calculations of storm water runoff and conveyance capacity have been determined as outlined in the Drainage Criteria Manual Section 2 and Section 6 respectively. Always evaluate the consequences of a measure failing when considering which control measure to use, as failure of a measure may be hazardous or damaging to both people and property. For examples, a large sediment basin failure can have disastrous results; and, low points along dikes can cause major gullies to form on a fill slope. It is essential to provide inspections to determine if BMPs are properly installed and functioning, and to ensure that problems are corrected as soon as they develop. An individual shall be assigned responsibility for inspection and maintenance of erosion and sedimentation controls.

C.2 Erosion Control BMPs

Temporary Erosion Controls should be considered the first line of defense for prevention of storm water pollution during construction activities. It is much more effective to maintain the soil cover in place than to trap sediments that are subject to movement because of exposure. In addition effective erosion prevention can result in cost savings, since repair of erosion damage can be minimized.

Permanent Erosion Controls are used to reduce the potential of erosion after construction activities are complete and to ensure proper stabilization of areas disturbed by construction.

Primary erosion control strategies are to divert runoff away from unstable areas or to provide a stable surface that will resist the effects of rain and runoff. The principle measures for diverting runoff during construction include perimeter swales and dikes, and slope drains. These measures can direct flow around the active construction area or transport storm water runoff safely across unstable areas.

Existing trees and vegetation should be protected to help maintain a stable ground surface and prevent loss of sediments and potentially valuable topsoil. Where temporary vegetation is planted to prevent erosion, blankets, matting and mulches can help stabilize the area until the vegetation is adequately established.

The following sections describe various erosion control measures. The types and application of the controls are summarized in Table C-1.

Table C-1 Guidelines for Selection of Temporary Erosion Control BMPs

Erosion Control	Area	Application	Notes
Interceptor Swale	< 5 ac	Used as a perimeter control or to shorten slope distances	
Diversion Dike	<10 ac	Used to route runoff away from disturbed Areas	
Pipe Slope Drain	<5 ac	Transport runoff down steep, erodible Slopes	
Channel Stabilization	Along Channels	Conveyance of concentrated runoff	
Outlet Stabilization	At Outlets	Prevent erosion at outlet of channel or Conduit	
Level Spreader	Based on flow	Outlet device for dikes and diversions	Slope <10% and stable
Subsurface Drain	Sized as Req'd.	Prevent soils from becoming saturated and prevent seeps	
Vegetation	Up to Mild Slopes	Temporary and permanent stabilization of disturbed areas	Permanent vegetation required for all disturbed areas
Blankets/Matting w/ vegetation	Step Slopes	Used in channels and on steep slopes	Suggested max. slope 2H:1V for slope applications
Brush Mulch/ Erosion Control Logs	NA	Temp. stabilization of disturbed areas Stabilization in channels, around inlets, on steep slopes	Suggested max. slope 2H:1V for slope applications
Hydraulic Mulch;	Small Channel	Stabilization of newly seeded areas	Suggested max. slope 3H:1V
Sod	Up to Mild Slopes	Immediate stabilization in channels, around inlets, or for aesthetics	
Dust Control	As Req'd.	Areas subject to on- or off-site impacts from surface/air movement of dust	

Final Stabilization is defined as a uniform establishment (e.g. unevenly distributed, without large bare areas) of vegetation cover as defined in Standard Specification 604 – Seeding for Erosion Control on all unpaved areas and areas not covered by permanent structures, or other permanent stabilization measures, such as rip-rap, gabions, or geotextile fabric, have been employed and soil disturbance activities at the site have ceased.

Removal of vegetative cover and alteration of soil structure by clearing, grading, and compacting the surface increases an area's susceptibility to erosion. Apply stabilizing measures immediately after the land is disturbed. Plan and implement temporary or permanent vegetation, mulches, or other protective practices to correspond with construction activities. Protect channels from erosive forces by using protective linings and the appropriate channel design. Table C-2 provides guidance for appropriate stabilization of temporary and permanent open channels. Outlet stabilization and flow spreading measures must be implemented to reduce the effects of concentrated flow. Consider possible future repairs and maintenance of these practices in the design. Seeding establishes a

vegetative cover on disturbed areas and is very effective in controlling soil erosion once adequate vegetative cover has been established. However, often seeding and fertilizing do not produce as thick a vegetative cover as do seed and mulch or netting. Newly established vegetation does not have as extensive of a root system as existing vegetation and therefore is more prone to erosion, especially on steep slopes. Care should be taken when fertilizing to avoid untimely or excessive application. Salvaged topsoil can and should be used to revegetate a site. Sod can also be used to permanently stabilize an area.

The management of land by using ground cover reduces erosion by reducing the rate of runoff and raindrop impact. In very flat, non-sensitive areas with favorable soils, stabilization may involve simply seeding and fertilizing. Erosion blankets/matting may be necessary on steeper slopes, for erodible soils, and near sensitive areas. Sediment that has escaped the site due to the failure of sediment and erosion controls shall be cleaned up as soon as possible to minimize offsite impacts which may include roadways, ponds, lakes, and creeks. Permission shall be obtained from adjacent landowners prior to offsite sediment clean up.

Mulching/mats can be used to protect disturbed areas while vegetation is being established. Mulching involves applying plant residues or other suitable materials on disturbed soil surfaces. Mulches/mats used include tacked straw, wood chips, and jute netting and are often covered by blankets or netting. Mulching alone shall be used only for temporary protection of the soil surface or when permanent seeding is not feasible. The useful life of mulch varies with the material used, exposure of the area to traffic, and the amount of precipitation, but is approximately 2 to 6 months. During times of year when vegetation cannot be established, soil mulching shall be applied to moderate slopes and soils that are not highly erodible. Before stabilizing an area, it is important to have installed all sediment controls and diverted runoff away from the area to be planted. Runoff may be diverted away from denuded areas or newly planted areas using dikes, swales, or pipe slope drains to intercept runoff and convey it to a permanent channel or storm drain. If runoff cannot be diverted, as is often the case with drainage channels, the use of erosion blankets/matting should be considered to protect soil and seed until vegetation becomes established. The cost of the blankets/matting is often less than the cost of regrading, reseeding, clean-up of escaped sediments, replacing topsoil and maintaining temporary erosion controls.

**Table C-2 Ranges of Shear (pounds per square foot) by Depth and Slope
for Open Channel Flow**

Assumptions: Approximately 30 inches of rainfall a year (able to sustain a "fair" vegetative cover)
"fair soil" for vegetation growth. Soil silt, sand, clay mixture.
"hydraulically wide" channel with generally straight alignment

Notes: Shear around bends can be greater than these values depending upon ratio of bend radius to bottom width.
This chart is intended to be used as a quick visual guide and does not take the place of individual site analysis.
The divisions between the different zones are estimates and may vary with differing site conditions.

		SHEAR RANGE	SOIL STABILIZATION REQUIREMENTS
Legend:	ZONE 1	under 0.5 psf	None - bare soil (depending upon type of soil), vegetation required for permanent channels
	ZONE 2	up to 3 psf	Grass/vegetation
	ZONE 3	up to 6-8 psf	Soft armor (e.g. geosynthetic matting, erosion control blankets)
	ZONE 4	over 7 to 8 psf	Hard armor (e.g. rip rap, gabion)
	D = Water Depth		

Depth D (ft)	SLOPE (FT/FT)																				
	0.002	0.005	0.010	0.015	0.020	0.025	0.030	0.035	0.040	0.045	0.050	0.055	0.060	0.065	0.070	0.075	0.080	0.085	0.090	0.095	0.100
0.1	ZONE 1												ZONE 2								
0.3	0.01	0.03	0.06	0.09	0.12	0.16	0.19	0.22	0.25	0.28	0.31	0.34	0.37	0.41	0.44	0.47	0.50	0.53	0.56	0.59	0.62
0.5	0.04	0.09	0.19	0.28	0.37	0.47	0.56	0.66	0.75	0.84	0.94	1.03	1.12	1.22	1.31	1.40	1.50	1.59	1.68	1.78	1.87
0.7	0.06	0.16	0.31	0.47	0.62	0.78	0.94	1.09	1.25	1.40	1.56	1.72	1.87	2.03	2.18	2.34	2.50	2.65	2.81	2.96	3.12
1.0	0.09	0.22	0.44	0.66	0.87	1.09	1.31	1.53	1.75	1.97	2.18	2.40	2.62	2.84	3.06	3.28	3.49	3.71	3.93	4.15	4.37
1.2	0.12	0.31	0.62	0.94	1.25	1.56	1.87	2.18	2.50	2.81	3.12	3.43	3.74	4.06	4.37	4.68	4.99	5.30	5.62	5.93	6.24
1.4	0.15	0.37	0.75	1.12	1.50	1.87	2.25	2.62	3.00	3.37	3.74	4.12	4.49	4.87	5.24	5.62	5.99	6.36	6.74	7.11	7.49
1.6	0.17	0.44	0.87	1.31	1.75	2.18	2.62	3.06	3.49	3.93	4.37	4.80	5.24	5.68	6.12	6.55	6.99	7.43	7.86	8.30	8.74
1.8	0.20	0.50	1.00	1.50	2.00	2.50	3.00	3.49	3.99	4.49	4.99	5.49	5.99	6.49	6.99	7.49	7.99	8.49	8.99	9.48	9.98
2.0	0.22	0.56	1.12	1.68	2.25	2.81	3.37	3.93	4.49	5.05	5.62	6.18	6.74	7.30	7.86	8.42	8.99	9.55	10.11	10.67	11.23
2.2	0.25	0.62	1.25	1.87	2.50	3.12	3.74	4.37	4.99	5.62	6.24	6.86	7.49	8.11	8.74	9.36	9.98	10.61	11.23	11.86	12.48
2.4	0.27	0.69	1.37	2.06	2.75	3.43	4.12	4.80	5.49	6.18	6.86	7.55	8.24	8.92	9.61	10.30	10.98	11.67	12.36	13.04	13.73
2.6	0.30	0.75	1.50	2.25	3.00	3.74	4.49	5.24	5.99	6.74	7.49	8.24	8.99	9.73	10.48	11.23	11.98	12.73	13.48	14.23	14.98
2.8	0.32	0.81	1.62	2.43	3.24	4.06	4.87	5.68	6.49	7.30	8.11	8.92	9.73	10.55	11.36	12.17	12.98	13.79	14.60	15.41	16.22
3.0	0.35	0.87	1.75	2.62	3.49	4.37	5.24	6.12	6.99	7.86	8.74	9.61	10.48	11.36	12.23	13.10	13.98	14.85	15.72	16.60	17.47
3.2	0.37	0.94	1.87	2.81	3.74	4.68	5.62	6.55	7.49	8.42	9.36	10.30	11.23	12.17	13.10	14.04	14.98	15.91	16.85	17.78	18.72
3.4	0.40	1.00	2.00	3.00	3.99	4.99	5.99	6.99	7.99	8.99	9.98	10.98	11.98	12.98	13.98	14.98	15.97	16.97	17.97	18.97	19.97
3.6	0.42	1.06	2.12	3.18	4.24	5.30	6.36	7.43	8.49	9.55	10.61	11.67	12.73	13.79	14.85	15.91	16.97	18.03	19.09	20.16	21.22
3.8	0.45	1.12	2.25	3.37	4.49	5.62	6.74	7.86	8.99	10.11	11.23	12.36	13.48	14.60	15.72	16.85	17.97	19.09	20.22	21.34	22.46
4.0	0.47	1.19	2.37	3.56	4.74	5.93	7.11	8.30	9.48	10.67	11.86	13.04	14.23	15.41	16.60	17.78	18.97	20.16	21.34	22.53	23.71
4.2	0.50	1.25	2.50	3.74	4.99	6.24	7.49	8.74	9.98	11.23	12.48	13.73	14.98	16.22	17.47	18.72	19.97	21.22	22.46	23.71	24.96
4.4	0.52	1.31	2.62	3.93	5.24	6.55	7.86	9.17	10.48	11.79	13.10	14.41	15.72	17.04	18.35	19.66	20.97	22.28	23.59	24.90	26.21
4.6	0.55	1.37	2.75	4.12	5.49	6.86	8.24	9.61	10.98	12.36	13.73	15.10	16.47	17.85	19.22	20.59	21.96	23.34	24.71	26.08	27.46
4.8	0.57	1.44	2.87	4.31	5.74	7.18	8.61	10.05	11.48	12.92	14.35	15.79	17.22	18.66	20.09	21.53	22.96	24.40	25.83	27.27	28.70
5.0	0.60	1.50	3.00	4.49	5.99	7.49	8.99	10.48	11.98	13.48	14.98	16.47	17.97	19.47	20.97	22.46	23.96	25.46	26.96	28.45	29.95
5.5	0.62	1.56	3.12	4.68	6.24	7.80	9.36	10.92	12.48	14.04	15.60	17.16	18.72	20.28	21.84	23.40	24.96	26.52	28.08	29.64	31.20
6.0	0.69	1.72	3.43	5.15	6.86	8.58	10.30	12.01	13.73	15.44	17.16	18.88	20.59	22.31	24.02	25.74	27.46	29.17	30.89	32.60	34.32
6.5	0.75	1.87	3.74	5.62	7.49	9.36	11.23	13.10	14.98	16.85	18.72	20.59	22.46	24.34	26.21	28.08	29.95	31.82	33.70	35.57	37.44
7.0	0.81	2.03	4.06	6.08	8.11	10.14	12.17	14.20	16.22	18.25	20.28	22.31	24.34	26.36	28.39	30.42	32.45	34.48	36.50	38.53	40.56
	0.87	2.18	4.37	6.55	8.74	10.92	13.10	15.29	17.47	19.66	21.84	24.02	26.21	28.39	30.58	32.76	34.94	37.13	39.31	41.50	43.68
	ZONE 3												ZONE 4								

Adapted from Andy Johnston, P.E.

C.2.1 Interceptor Swale

Interceptor swales are used to shorten the length of exposed slope by intercepting runoff and can also serve as perimeter swales preventing off-site runoff from entering the disturbed area or prevent sediment-laden runoff from leaving the construction site or disturbed area. They may have a v-shape or be trapezoidal with a flat bottom and side slopes of 3:1 or flatter. The outflow from a swale should be directed to a stabilized outlet or sediment-trapping device. The swales shall remain in place until the disturbed area is permanently stabilized or until an alternative plan, approved by the City, is in place. A schematic of an interceptor swale is shown in Figure C-1.

Materials:

- Stone stabilization shall be used when grades exceed 2% or velocities exceed 6 feet per second and should consist of a layer of crushed stone three inches thick, riprap or high velocity erosion control mats.
- Stabilization shall extend across the bottom of the swale and up both sides of the channel to a minimum height of three inches above the design water surface elevation based on a 1-year, 3-hour storm, or the design discharge of the water conveyance structure, whichever is greater.

Installation:

- An interceptor swale shall be installed across exposed slopes during construction and shall intercept no more than 5 acres of runoff.
- All earth removed and not needed in construction shall be disposed of in an approved spoils site or temporarily stored for future use in a protected area so that it will not interfere with the functioning of the swale or contribute to siltation in other areas of the site.
- All trees, brush, stumps, obstructions and other material shall be removed and disposed of so as not to interfere with the proper functioning of the swale.
- Swales shall have a maximum designed water depth of 1.5 feet with a 0.5 foot freeboard and with side slopes of 3:1 or flatter. Swales shall have positive drainage for its entire length to an outlet.
- When the slope exceeds 2 percent, or velocities exceed 6 feet per second (regardless of slope), stabilization is required. Stabilization shall be

crushed stone placed in a layer of at least 3 inches thick or may be high velocity erosion control matting. Check dams (see section C.3.9) are also recommended to reduce velocities in the swales possibly reducing the amount of stabilization necessary.

- Minimum compaction for the swale shall be 90% standard proctor density.

Inspection and Maintenance Guidelines:

- Interceptor swales should be inspected weekly, prior to forecasted rain events, and after each rain event to locate and repair any damage to the swale or clear debris or other obstructions so as not to diminish flow capacity.
- Damage from storms or normal construction activities such as tire ruts or disturbance of swale stabilization shall be repaired immediately.

C.2.2 Diversion Dikes

A temporary diversion dike is a barrier created by the placement of an embankment to reroute the flow of runoff to an erosion control device or away from an open, easily erodible area. A diversion dike intercepts runoff from small upland areas and diverts it away from exposed slopes to a stabilized outlet, such as a rock berm, sandbag berm, or stone outlet structure. These controls can be used on the perimeter of the site to prevent runoff from entering the construction area. Dikes are generally used for the duration of construction to intercept and reroute runoff from disturbed areas to prevent excessive erosion until permanent drainage features are installed and/or slopes and disturbed areas are stabilized. Caution must be exercised when implementing diversion dikes to ensure against adverse flooding caused to upstream property. A schematic of a diversion dike is shown in Figure C-2.

Materials:

- Stone stabilization (required for velocities in excess of 6 fps) should consist of erosion control matting or crushed 3-5 inch stone placed in a layer at least 5 inches thick extending a minimum height of 8 inches above the design water surface on the upstream face of the dike and up the existing slope upstream of the dike. Geotextile fabric shall be a non-woven polypropylene fabric designed specifically for use as a soil filtration media with an approximate weight of 4 oz. /yd²

Installation:

- Diversion dikes shall be installed prior to and maintained for the duration of construction and shall intercept no more than 10 acres of runoff.
- Dikes shall have a minimum top width of 2 feet and a minimum height of compacted fill of 18 inches measured from the top of the existing ground at the upslope toe to top of the dike and having side slopes of 3:1 or flatter. The top of the dike shall provide a 0.5 foot freeboard above the design water elevation.
- The soil for the dike shall be placed in lifts of 8 inches or less and be compacted to 95 % standard proctor density.
- The channel, which is formed by the dike, must have positive drainage for its entire length to an outlet.
- When the slope exceeds 2 percent, or velocities exceed 6 feet per second (regardless of slope), stabilization is required. Situations in which velocities do not exceed 6 feet per second, vegetation may be used to control erosion.

Inspection and Maintenance Guidelines:

- Swales shall be inspected weekly, prior to forecasted rain events, and after each rain event to determine if silt is building up behind the dike or if erosion is occurring on the face of the dike. Locate and repair any damage to the dike or channel and clear debris or other obstructions so as not to diminish flow capacity.
- Silt shall be removed in a timely manner to prevent further sediment transportation and to maintain the effectiveness of the control.
- If erosion is occurring on the face of the dike, the slopes of the face should either be stabilized through mulch or seeding or the slopes of the face should be reduced.
- Damage from storms or normal construction activities such as tire ruts or disturbance of stone stabilization shall be repaired as soon as practical.

C.2.3 Pipe Slope Drain

A pipe slope drain is an erosion control device that combines a diversion dike and a pipe to prevent runoff over an exposed slope and to carry runoff to a stabilized outlet apron. The maximum area contributing to any one drain should be 5 acres or less. The pipe shall be sized to convey the 1-year, 3-hr storm or

the design discharge of the water conveyance structure, whichever is greater. A diagram of a slope drain is shown in **Error! Reference source not found.3**.

Materials:

- The drain pipe shall be made of any material, rigid or flexible, which is capable of conveying runoff. The drainpipe shall be completely watertight so that no water leaks on to the slope to be protected.
- Riprap to be used in the outlet apron should consist of either crushed stone or broken Portland cement concrete. All stones used should weigh between 50 and 150 pounds each and should be as nearly uniform as is practical.

Installation:

- A diversion dike shall be constructed at the top of the slope that is to be protected. This dike shall be sized and installed in accordance with section C.2.2 "Diversion Dikes". The soil around and under the entrance section of the drainpipe shall be hand-tamped in 8-inch lifts to prevent piping failure around the inlet.
- The height of the diversion dike at the centerline of the inlet shall be equal to the diameter of the pipe plus 12 inches.
- A rigid section of pipe shall be installed through the dike. A standard flared-end section with an integral toe plate extending a minimum of 6-inches from the bottom of the end section shall be attached to the inlet end of the pipe using watertight fittings.
- A riprap-lined apron shall be excavated to accept the runoff from the pipe and dissipate the energy of the flow. The width of the bottom of the apron shall be 3 times the pipe diameter and the length shall be a minimum of 6 times the pipe diameter. The apron shall be a minimum of 12-inches deep and lined with riprap with a thickness of at least 12 inches. The apron shall be designed so that the released flow has a velocity less than 3 feet per second.

Inspection and Maintenance Guidelines:

- Temporary pipe slope drains shall be inspected weekly and after each rain event to locate and repair any damage to joints or clogging of the pipe.
- In cases where the diversion dike has deteriorated around the entrance of the pipe, it may be necessary to reinforce the dike with sandbags or to install a concrete collar to prevent failure.
- Signs of erosion around the pipe drain shall be addressed in a timely manner by stabilizing the area with erosion control mats, crushed stone, concrete or other appropriate method.

C.2.4 Channel Stabilization

Temporary roadside ditches, drainage channels and similar conveyances must be properly designed and stabilized to resist erosion from the design flows. New or altered channels can be lined with grass, erosion blankets/matting, rip rap revetment or other materials. The channels should be designed in accordance with section 6 of this manual. Key parameters in channel design include permissible velocity, roughness coefficient, side slope, curvature, bottom width, and freeboard.

Materials:

- Grass, erosion blankets/matting, or rip rap revetment as determined by maximum velocity and shear stress (see Table C-2). The grass species selected must be suitable for permanent application based upon the anticipated operation and maintenance of the channel or waterway.

Design Guidelines:

- The maximum permissible velocity for a grassed channel is six (6) feet per second and includes all transitions to or from channels and waterways with similar or different materials. In all cases, the velocity for design storm must be non-erosive. Shear stress may be significant even at lower velocities. Table C-2 should be consulted to determine if armoring of the channel is appropriate. Refer to Section C.2.11 for erosion blanket/matting guidance. Figure C-4 provides sizing guidelines for rock rip rap. U.S. Army Corps of Engineers Circular HEC-11 should be referenced for further details regarding rip rap revetment design.

- Side slopes shall be 3H:1V or flatter. Steeper slopes will require stabilization in the form of erosion blankets/matting, rock rip rap or structural methods. Refer to Section C.2.11 for blankets/matting.
- The roughness coefficients selected shall be based on the degree of retardance of vegetation. Section 6 of this manual provides minimum Manning's Coefficients for channel design. The roughness coefficient shall be adjusted to reflect the relationship between the depth of flow and the typical height of the design vegetation, especially for shallow depths of flow, as well as other factors affecting channel conveyance.

Installation:

- Refer to section C.2.8 and C.2.11 for guidance regarding vegetation establishment and blankets/matting.

Inspection and Maintenance Guidelines:

- Channels shall be inspected periodically and after any significant rain events to locate and repair any damage to the channel or clear debris or other obstructions so as not to diminish flow capacity.
- Damage from storms or vehicles should be repaired as soon as practical.

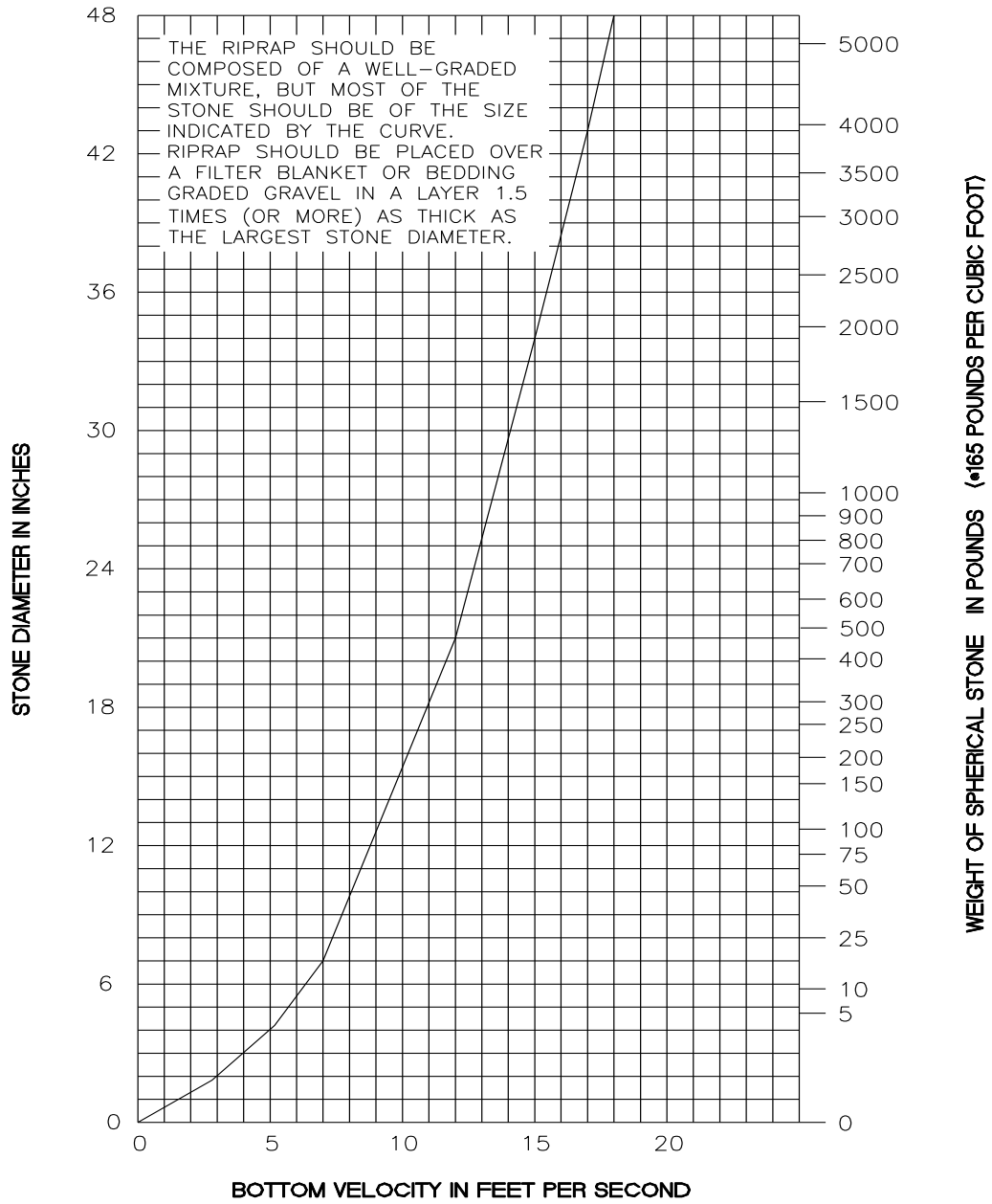

Figure C-4 Rock Riprap Size Selection

C.2.5 Outlet Stabilization

The goal of outlet stabilization is to prevent erosion at the outlet of a channel or conduit by reducing the velocity of flow and dissipating the energy. This practice applies where the discharge velocity of a pipe, box culvert, diversion, open channel, or other water conveyance structure exceeds the permissible velocity of the receiving channel or disposal area.

The outlets of channels, conduits, and other structures are points of high erosion potential, because they frequently carry flows at velocities that exceed the allowable limit for the area downstream. To prevent scour and undermining, an outlet stabilization structure is needed to absorb the impact of the flow and reduce the velocity to non-erosive levels. A riprap-lined apron is the most commonly used practice for this purpose because of its relatively low cost and ease of installation. The riprap apron should be extended downstream until stable conditions are reached even though this may exceed the length calculated for design velocity control.

- Riprap-stilling basins or plunge pools reduce flow velocity rapidly. They should be considered in lieu of aprons where overfalls exit at the ends of pipes or where high flows would require excessive apron length. Consider other energy dissipaters such as concrete impact basins or paved outlet structures where site conditions warrant. U.S. Army Corps of Engineers Circular HEC-14 should be referenced for further details regarding energy dissipation.

Materials:

- **Materials**—Ensure that riprap consists of a well-graded mixture of stone. Larger stone should predominate, with sufficient smaller sizes to fill the voids between the stones. The maximum stone diameter should be no greater than 1.5 times the d_{50} size. Refer to Figure C-4 for appropriate stone size.
- **Thickness**—The minimum thickness of riprap shall be 1.5 times the maximum stone diameter.
- **Stone quality**—Select stone for riprap from field stone or quarry stone. The stone should be hard, angular, and highly weather-resistant. The specific gravity of the individual stones should be at least 2.5.
- **Filter Blanket/ Geotextile Fabric**—Install appropriate barrier to prevent soil movement through the openings in the riprap. The barrier should consist of a graded gravel layer or a synthetic filter cloth beneath the riprap.

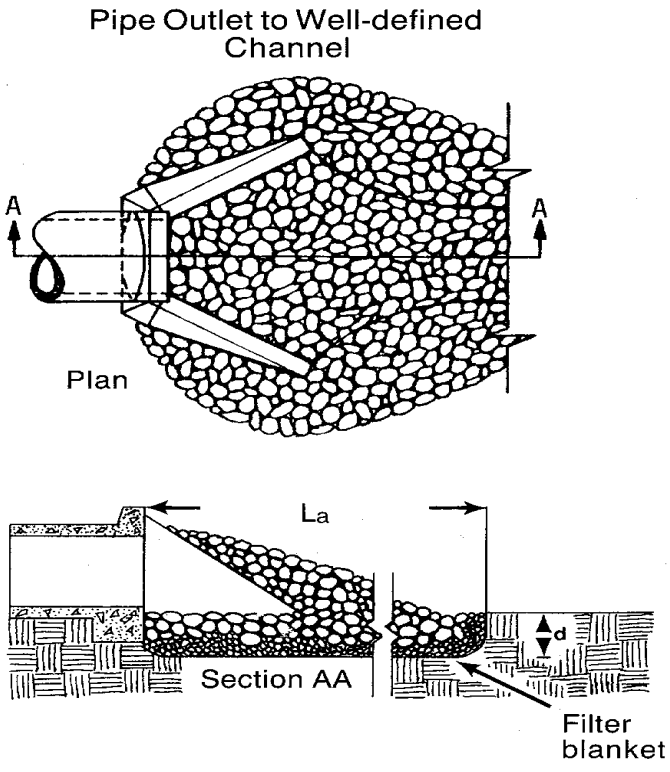
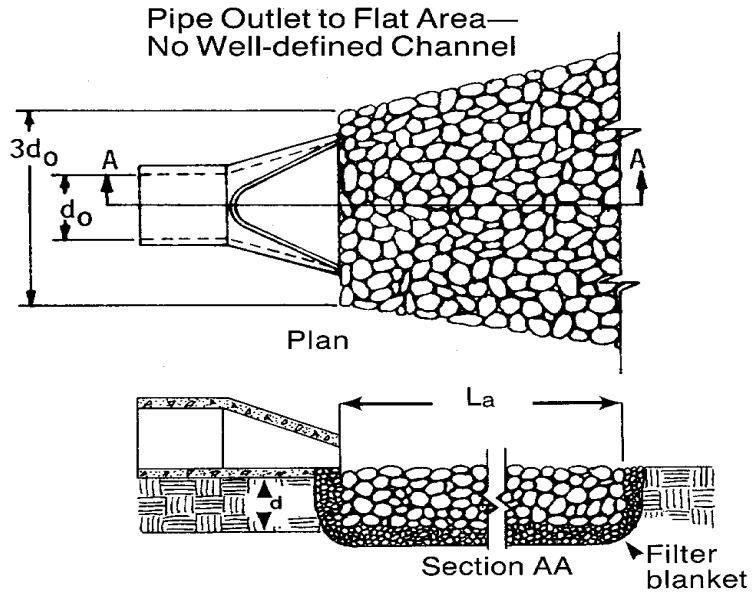

- Notes**
1. L_a is the length of the riprap apron.
 2. $d = 1.5$ times the maximum stone diameter but not less than 6".
 3. In a well-defined channel extend the apron up the channel banks to an elevation of 6" above the maximum tailwater depth or to the top of the bank, whichever is less.
 4. A filter blanket or filter fabric should be installed between the riprap and soil foundation.

Figure C-5 Schematic Riprap Outlet Design

Design Guidelines:

- Capacity - outlet stabilization should be designed in accordance with local drainage criteria (see Section 5).
- Apron size - If the water conveyance structure discharges directly into a well-defined channel, extend the apron across the channel bottom and up the channel banks to an elevation of 0.5 ft above the maximum tailwater depth or to the top of the bank, whichever is less. Determine the maximum allowable velocity for the receiving stream, and design the riprap apron to reduce flow to this velocity before flow leaves the apron. Calculate the apron length for velocity control or use the length required to meet stable conditions downstream, whichever is greater. If the allowable downstream velocity cannot be readily determined, the following relationship may be used:

Equation C.1 **$La = 0.5 V * D$**

Where: La = Length of rip rap apron, ft
 V = Culvert discharge velocity, ft/s
 D = inside diameter or height of culvert, ft

- Grade - Ensure that the apron has zero grade. There should be no overfall at the end of the apron; that is, the elevation of the top of the riprap at the downstream end should be the same as the elevation of the bottom of the receiving channel or the adjacent ground if there is no channel.
- Alignment - The apron should be straight throughout its entire length, but if a curve is necessary to align the apron with the receiving stream, locate the curve in the upstream section of riprap.

Installation:

- Ensure that the subgrade for the fabric and riprap follows the required lines and grades shown in the plan. Compact any fill required in the subgrade to the density of the surrounding undisturbed material. Low areas in the subgrade on undisturbed soil may also be filled by increasing the riprap thickness.
- The riprap and fabric must conform to the specified grading limits shown on the plans.
- Filter cloth must be properly protected from punching or tearing during installation. Repair any damage by removing the riprap and placing

another piece of filter cloth over the damaged area. All connecting joints should overlap a minimum of 1 ft. If the damage is extensive, replace the entire filter cloth.

- Riprap may be placed by equipment, but take care to avoid damaging the fabric.
- The minimum thickness of the riprap should be 1.5 times the maximum stone diameter.
- Riprap may be field stone or rough quarry stone. It should be hard, angular, highly weather-resistant and well graded.
- Construct the apron on zero grade with no overfall at the end. Make the top of the riprap at the downstream end level with the receiving area or slightly below it.
- Ensure that the apron is properly aligned with the receiving stream and preferably straight throughout its length. If a curve is needed to fit site conditions, place it in the upper section of the apron.
- Immediately after construction, stabilize all disturbed areas with vegetation.

Inspection and Maintenance Guidelines:

Inspect riprap outlet structures after heavy rains to see if any erosion around or below the riprap has taken place or if stones have been dislodged. Immediately make all needed repairs to prevent further damage.

C.2.6 Level Spreaders

A level spreader is used to convert concentrated runoff into sheet flow and release it uniformly onto areas stabilized by existing vegetation. Sheet flow conditions are recommended prior to runoff entering a vegetative filter strip or a creek buffer. During the construction process, level spreaders can be used where there is a need to divert storm water away from disturbed areas to avoid overstressing erosion control measures or where storm runoff can be released in sheet flow down a stabilized slope without causing erosion.

This section presents a flow spreader consisting of an excavated depression constructed at zero grade across a slope with a level lip. Multiple options are provided for the level lip and include a grass hedge row, reinforced vegetation, a rock berm, and a rigid timber lip. Refer to Figures C-6 and C-7 for a schematic and cross sections of these various options. Other flow spreader designs can be

used as long as they convert concentrated runoff to sheet flow as defined in this section.

Sheet flow is defined at a flow depth of less than 0.2 feet or 2.4 inches and a velocity of less than one (1) foot per second during the peak flowrate from the 1-year, 3-hour storm event under fully-developed conditions. The hydrologic and hydraulic reference tables in Section 2 and 6 of this manual respectively can be used with the Rational Method to determine the fully-developed peak flow rate. The following equation based on the Continuity Equation ($Q=VA$) can be used to determine the required flow spreader length.

Equation C.2 $L = 5Q_{1\text{Year-Dev}}$

Where: L = minimum required length of flow spreader (ft)
 Q_{1YR} = fully-developed peak flow rate for the 1-yr, 3-hr storm event (cfs)

Particular care should be taken to construct the outlet lip at a level elevation in a stable, undisturbed soil. Any depression in the lip will concentrate the flow, potentially resulting in erosion. Under higher design flow conditions, a rigid outlet lip design should be used to create the desired sheet flow conditions. Runoff water containing high sediment loads must be treated in a sediment-trapping device before being released to a level spreader.

Installation:

- Level spreaders should be constructed on undisturbed soil (not fill material)
- The entrance to the spreader should be shaped in such a manner as to insure that runoff enters directly onto the 0% grade channel
- Construct a transition section from the diversion channel to blend smoothly to the width and depth of the spreader.
- The level lip should be constructed at 0% grade to insure uniform spreading of storm water runoff.
- Immediately after its construction, establish vegetation along the entire disturbed area of the spreader. A vegetative cover density of 80% with no large bare areas is required.
- Level spreaders are to be staked along a contour prior to construction.

Inspection and Maintenance Guidelines:

- Level spreaders used temporarily or permanently established during construction activities shall be inspected weekly, prior to forecasted rainfall events, and after rainfall events. Level spreaders shall be inspected annually and repairs made, if required.
- Level spreader lip should remain at 0% slope to allow proper function of measure.
- The contractor should avoid the placement of any material on and prevent construction traffic across the structure. If the measure is damaged by construction traffic, it should be repaired immediately.

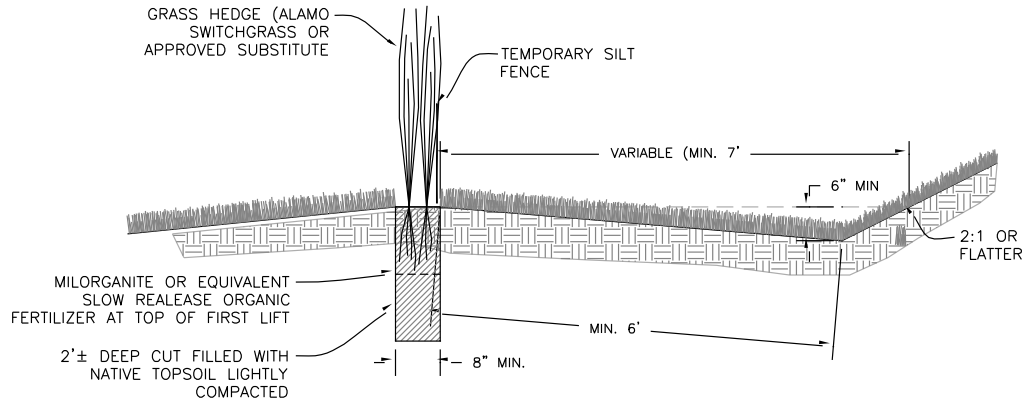

LEVEL SPREADER WITH GRASS HEDGE ROW

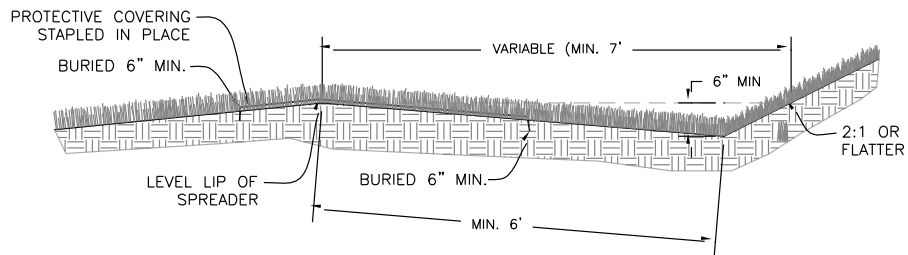

LEVEL SPREADER WITH REINFORCED VEGETATED LIP

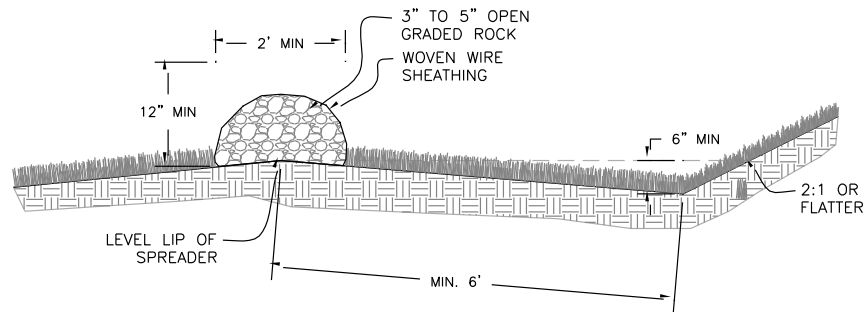

LEVEL SPREADER WITH ROCK BERM LIP

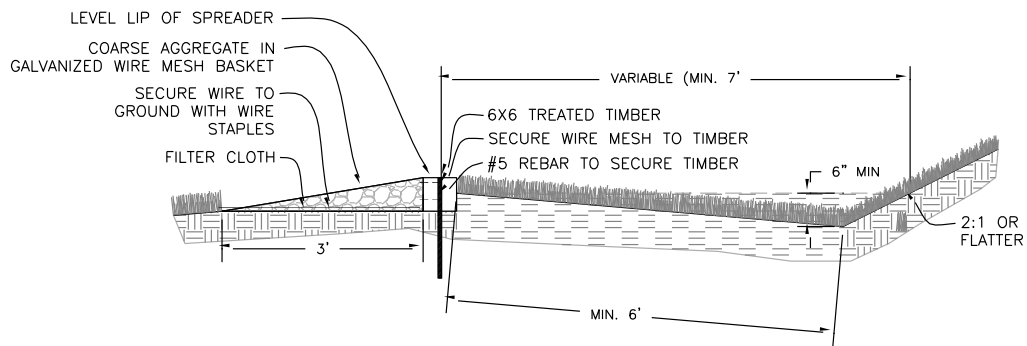

LEVEL SPREADER WITH RIGID TIMBER LIP

Figure C-7: Level Spreader Lip Options

C.2.7 Subsurface Drains

A subsurface drain is a perforated conduit such as pipe, tubing or tile installed beneath the ground to intercept and convey ground water. The main purposes are to: prevent sloping soils from becoming excessively wet and subject to sloughing, improve the quality of the growth medium in excessively wet areas by lowering the water table (see Figure C-8), or drain storm water detention areas or structures.

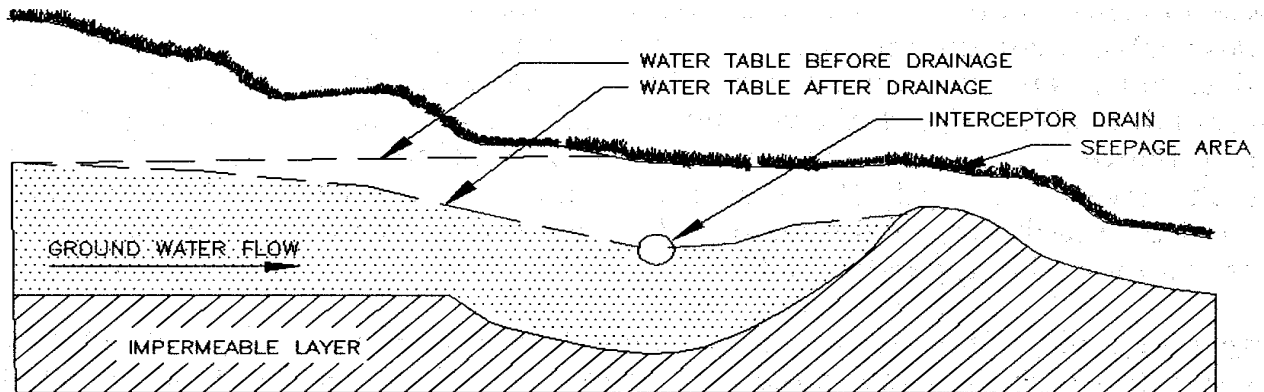

Figure C-8 Effect of Subsurface Drain

This measure is appropriate wherever excess water must be removed from the soil. The soil must be deep and permeable enough to allow an effective system to be installed. Either a gravity outlet must be available or pumping must be provided. These standards do not apply to foundation drains.

Subsurface drainage systems are of two types, relief drains and interceptor drains. Relief drains are used either to lower the water table in order to improve the growth of vegetation, or to remove surface water. They are installed along a slope and drain in the direction of the slope. They can be installed in a gridiron pattern, a herringbone pattern, or a random pattern (see Figure C-9).

Interceptor drains are used to remove water as it seeps down a slope to prevent the soil from becoming saturated and subject to slippage. They are installed across a slope and drain to the side of the slope. They usually consist of a single pipe or series of single pipes instead of a patterned layout.

Materials:

Acceptable materials for subsurface drains include perforated, continuous closed-joint conduits of pvc, corrugated plastic, concrete, and corrugated metal.

The strength and durability of the pipe should meet the requirements of the site in accordance with the manufacturer's specifications.

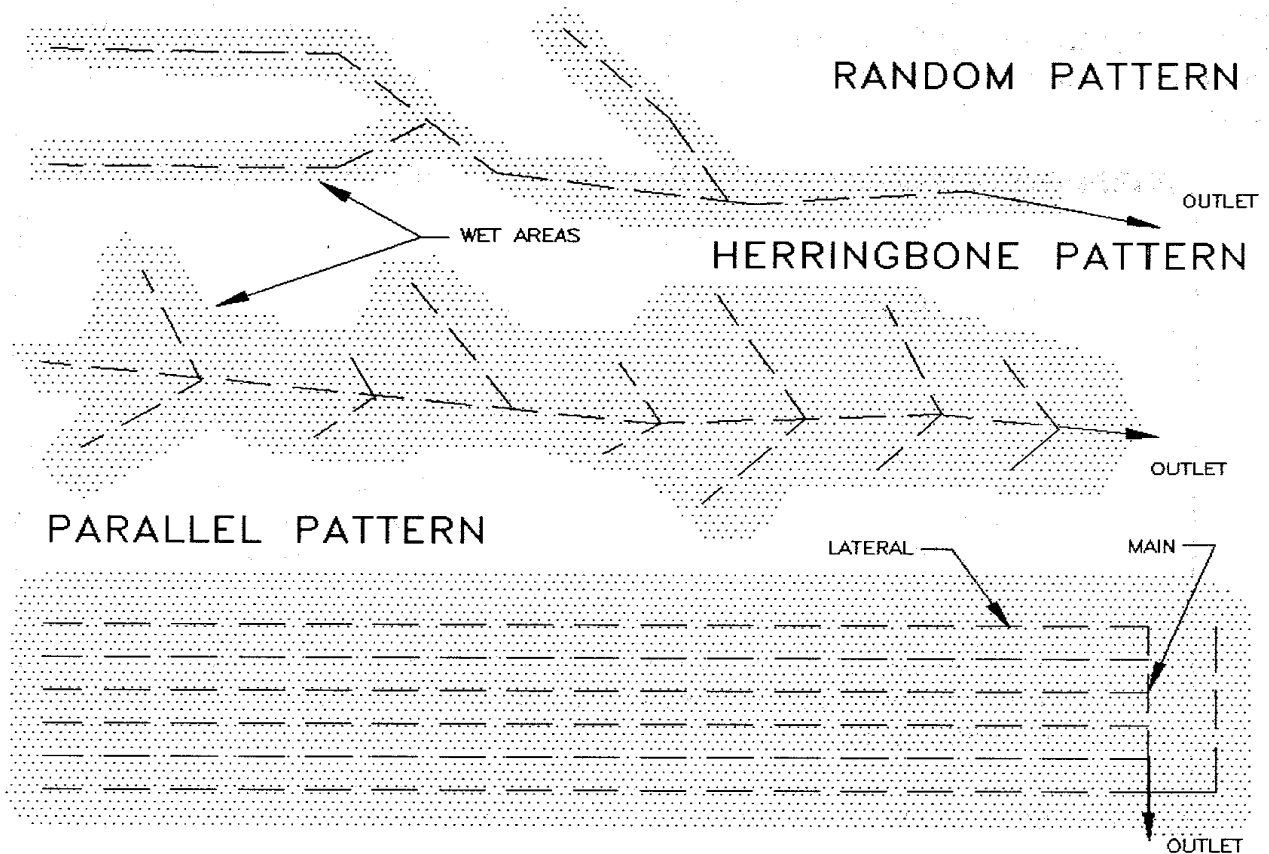

Figure C-9 Subsurface Drainage Patterns

General Installation Requirements:

- The trench should be constructed on a continuous grade with no reverse grades or low spots.
- Soft or yielding soils under the drain should be stabilized with gravel or other suitable material.
- Deformed, warped, or otherwise unsuitable pipe should not be used. The minimum diameter for a subsurface drain should be 4 inches.
- Aggregate envelopes (1" to 1½" crushed stone) and filter material should be placed as specified with at least 6 inches of material on all sides of the pipe.

- The trench should be backfilled immediately after placement of the pipe. No sections of pipe should remain uncovered overnight or during a rainstorm. Backfill material should be placed in the trench in such a manner that the drain pipe is not displaced or damaged.

Relief Drain Installation:

- Relief drains should be located through the center of wet areas. They should drain in the same direction as the slope.
- Relief drains installed in a uniform pattern should remove a minimum of 1 inch of groundwater in 24 hours (0.042 cfs/acre). Relief drains installed in a random pattern should remove a minimum of 1.5 cfs/1000 feet of length. The design capacity should be increased accordingly to accommodate any surface water which enters directly into the system (see Figure C-9).
- Relief drains installed in a uniform pattern should have equal spacing between drains and the drains should be at the same depth. Maximum depth is limited by the allowable load on the pipe, depth to impermeable layers in the soil, and outlet requirements. The minimum depth is 24 inches under normal conditions. Twelve inches is acceptable where the drain will not be subject to equipment loading. Spacing between drains is dependent on soil permeability and the depth of the drain. In general, however, a depth of 3 feet and a spacing of 50 feet will be adequate.
- The minimum velocity required to prevent silting is 1.4 ft/sec. The line should be graded to achieve at least this velocity. Steep grades should be avoided, however.
- Envelopes of 1" to 1½" crushed stone should be used around all drains for proper bedding and improved flow of groundwater into the drain. The envelope should consist of 6 inches of aggregate placed completely around the drain. The stone should be encompassed by a filter cloth separator to prevent the migration of surrounding soil particles into the drain (see Figure C-11). Filter cloth must be designed specifically for soil filtration.
- The outlet of the subsurface drain should empty into a channel or some other watercourse that will remove the water from the outlet. It should be above the normal water level in the receiving channel. It should be protected from erosion, undermining, damage from periods of submergence, and the entry of small animals into the drain.

Interceptor Drain Installation:

- Interceptor drains should remove a minimum of 1.5 cfs/1000 feet of length. This value should be increased for sloping land. In addition, if a flowing spring or surface water enters directly into the system, this flow must be accommodated and the design capacity should be increased accordingly to take care of this flow.
- The depth of installation of an interceptor drain is influenced mainly by the depth to which the water table is to be lowered. The maximum depth is limited by the allowable load on the pipe and the depth to an impermeable layer. The minimum depth should be the same as for relief drains.
- One interceptor drain is usually sufficient; however, if multiple drains are to be used, determining the required spacing can be difficult. The best approach is to install the first drain - then if seepage or high water table problems occur down slope, install an additional drain a suitable distance down slope.

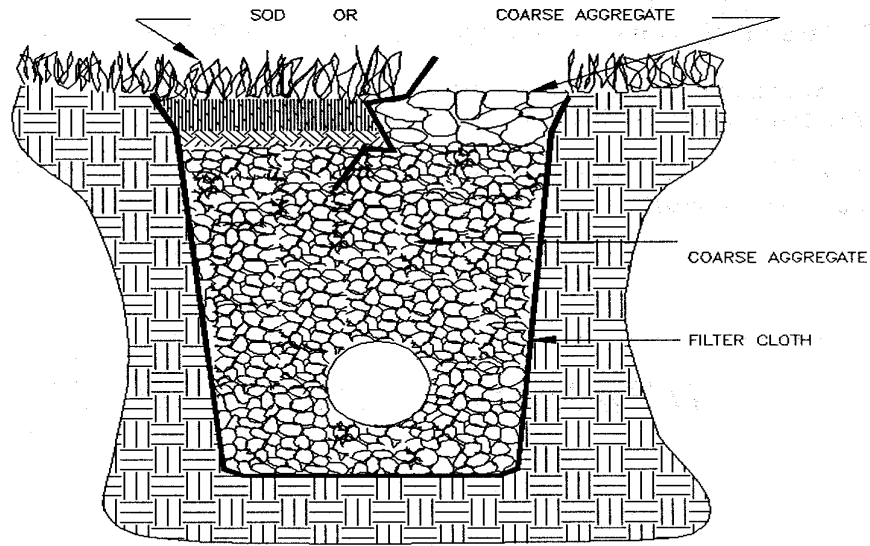

NATURAL INLET

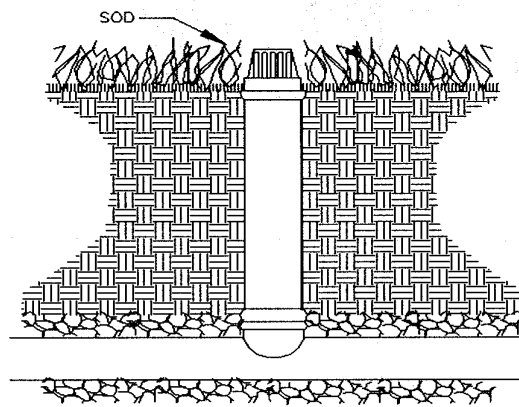

GRATED INLET

Figure C-10 Surface Inlets for Subsurface Drains Schematic

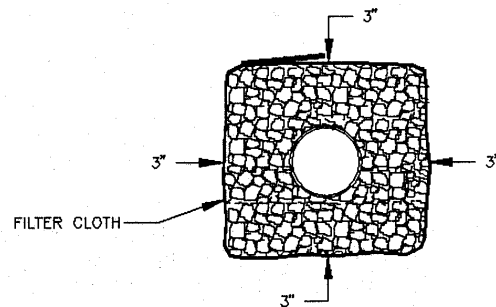

Figure C-11 Subsurface Drain Envelope Schematic

Inspection and Maintenance Guidelines:

- Subsurface drains should be checked periodically and after rainfall events to ensure that they are free flowing and not clogged with sediment.
- The outlet should be kept clean and free of debris.
- Surface inlets should be checked weekly, prior to forecasted rain events, after rainfall events, and kept open and free of sediment and other debris.
- Trees located too close to a subsurface drain often clog the system with their roots. If a drain becomes clogged, relocate the drain.
- Where heavy vehicles cross drains, the line should be checked to ensure that it is not crushed.

C.2.8 Vegetation

Vegetation is used as a temporary or permanent stabilization technique for disturbed areas. As a temporary control, vegetation can be used to stabilize stockpiles and barren areas that are inactive for long periods of time.

Vegetative techniques will apply to every construction project with few exceptions. Vegetation effectively reduces erosion in swales, stockpiles, berms, mild to medium slopes, and along roadways.

Other techniques may be required to assist in the establishment of vegetation. These other techniques include erosion control matting, mulches, surface roughening, swales and dikes to direct runoff around newly seeded areas, and proper grading to limit runoff velocities during construction. (NCTCOG, 1993b)

Native Versus Introduced Grasses:

Introduced grasses, such as Bermuda grass and K. R. bluestem, are frequently planted for erosion control purposes. They may provide superior soil protection, but they may also have disadvantages, particularly in areas where native grasses are the eventual goal.

Bermuda grass, for example is an excellent soil binder but it provides poor habitat for ground feeding birds (Anon., 1971). In infertile areas it can only be maintained with annual additions of nitrogen (Bieber, et. al., 1968). In areas where it is well established, it forms a uniform dense turf which retards the invasion of desirable native species and provides very low habitat and species diversity.

Bermuda grass or another introduced species is appropriate where the primary objective is erosion control. Alternatively, if there are other objectives

which include ecological, aesthetic or practical goals, native grasses are probably more appropriate. Since the goal of restoration efforts as discussed here is the establishment of natural vegetation, there seems to be no reason to plant introduced grasses. The only exception to this is when they are to be used as temporary ground cover in graded areas where ground work is incomplete and where they will be graded or plowed under later. If native grasses fail to become established in an area where it is possible for an introduced species to grow, the latter should of course be planted. But as a rule, introduced species shall be avoided.

Materials:

The type of vegetation used on a site is a function of the season and the availability of water for irrigation. For areas that are not irrigated, the year can be divided into two temporary planting seasons and one season for planting of permanent warm weather groundcovers. These periods are shown in Figure C-12 for central Texas. See Standard Specification 604 for seeding temporary and permanent areas for erosion control.

Bermuda grass has been traditionally specified for permanent vegetation, with the addition of Cereal or Winter Rye when seeding during cold months to provide temporary cover until the onset of the growing season for Bermuda grass. TxDOT has had success with native grasses and wildflowers and recent testing indicates that native species are more drought tolerant and equally effective in terms of erosion control. A native seed mixture containing Texas Wintergrass can be used throughout the year. Reuse of native topsoil stripped off and stockpiled during site clearing and grubbing provides an effective means to reestablish native vegetation as the topsoil will contain seed and root material. Williamson and Travis County agricultural extension agents are a good source for suggestions for other types of vegetation. All seed shall be high quality, U.S. Dept. of Agriculture certified seed.

Installation:

- Interim or final grading must be completed prior to seeding, minimizing all steep slopes. In addition, all necessary erosion structures such as dikes, swales, diversions, shall also be installed.
- Seedbed shall be well pulverized, loose, and uniform.
- A soil analysis is recommended to determine the amount of fertilization required. When seeding with non-native species, fertilizer may be applied at the rate of 40 pounds of nitrogen and 40 pounds of phosphorus per acre, which is equivalent to about 1.0 pounds of nitrogen and phosphorus per 1000 square feet. Compost can be used instead of fertilizer and applied at the same time as the seed.

- Seeding rates should be as specified in Standard Specification 604 or as recommended by a Williamson or Travis County agricultural extension agent.
- The seed shall be applied uniformly with a cyclone seeder, drill, cultipacker seeder or hydroseeder (slurry includes seed, fertilizer and binder). Seed may also be combined with hydraulic mulch (see Section C.2.13) and applied simultaneously.
- Protect the seedbed with a mulch layer to conserve soil moisture. Compost, hay or straw are recommended. Hay or straw mulch shall be applied at a rate of approximately 2 tons per acre. Organic Compost mulch application is covered in section C.2.12. Hay or straw mulch shall be anchored by crimping or application of an organic tackifier.
- Protect slopes that are steeper than 3H:1V and not exceeding 2H:1V with appropriate erosion blankets/matting as described in the section C.2.11 to prevent loss of soil and seed.
- Evaluate velocity and shear stress for drainage channels, diversion dikes and swales and protect with erosion blankets/matting as described in section C.2.11.

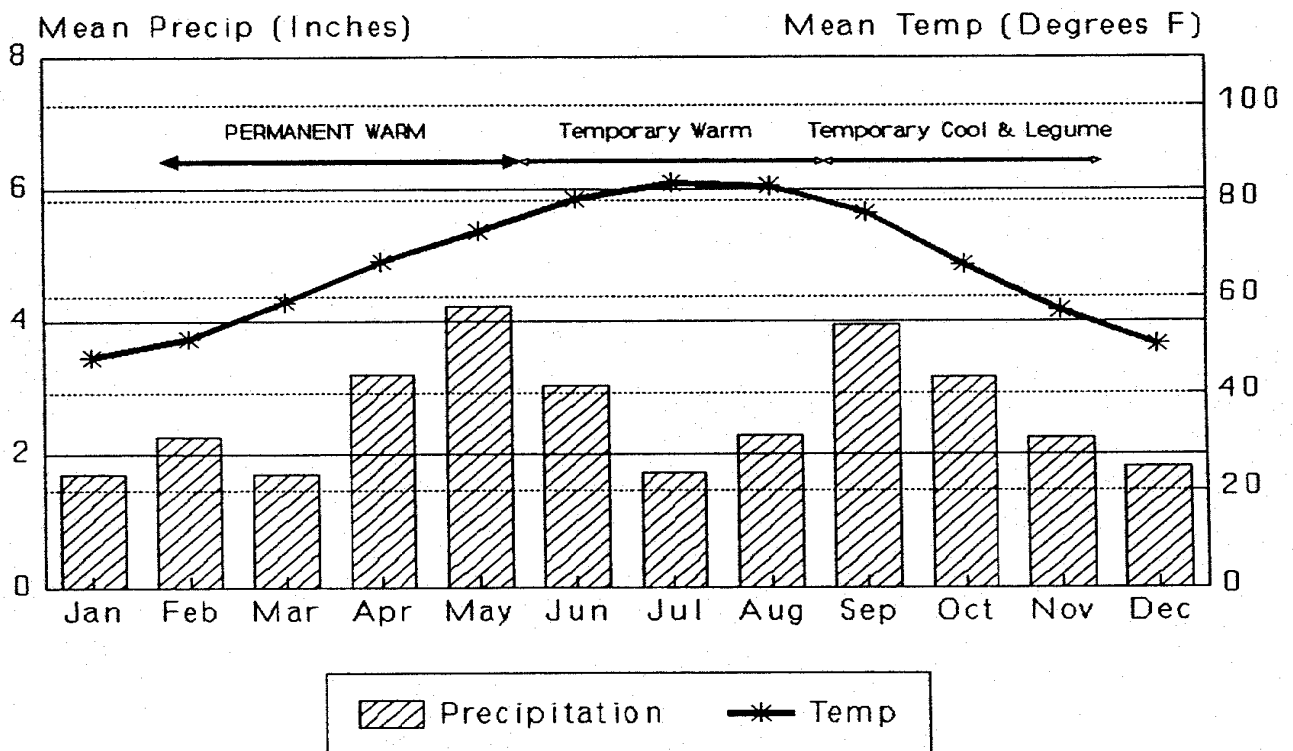

Figure C-12 Planting Dates for Central Texas

Irrigation Guidance:

Temporary irrigation shall be provided according to the schedule described below, or to replace moisture loss to evapotranspiration (ET), whichever is greater. Significant rainfall (on-site rainfall of ½” or greater) may allow watering to be postponed until the next scheduled irrigation. All automatic irrigation systems shall have a dual sensor rain shut off switch that automatically shuts off the irrigation systems when rain begins to fall and turns on the system if less than ½ inch of rain occurs.

Time Period	Irrigation Amount and Frequency
Within 2 hours of installation	Irrigate entire root depth, or to germinate seed
During the next 10 business Days	Irrigate entire root depth every Monday, Wednesday, and Friday
During the next 30 business days or until Substantial Completion	Irrigate entire root depth a minimum of once per week, or as necessary to ensure vigorous growth
During the next 4 months or until Final Acceptance of the Project	Irrigate entire root depth once every two Weeks, or as necessary to ensure vigorous Growth

Refer to Figure C-13, below, for average rainfall/ET data for the Austin area. This data shall serve as a guide to the overall watering regime; however, actual frequency and amount of irrigation water used shall be weather-dependent.

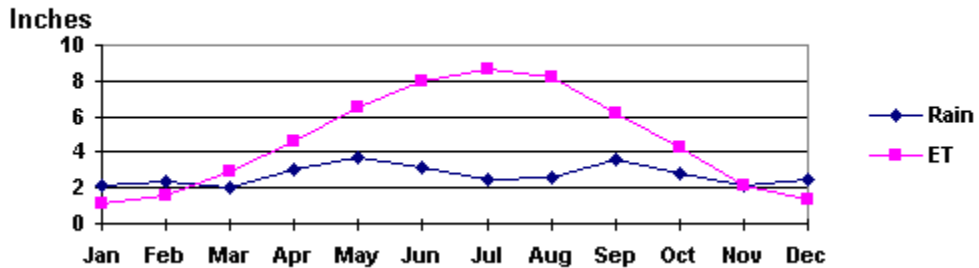

Figure C-13 Rainfall/ET Data for Austin

If cool weather induces plant dormancy, water only as necessary to maintain plant health. Irrigate in a manner that will not erode the topsoil but will sufficiently soak the entire depth of roots.

Inspection and Maintenance Guidelines:

- Areas with newly applied vegetation shall be inspected weekly and after each rain event to locate and repair any erosion or other damage.

- Erosion from storms or other damage shall be repaired as soon as practical by regrading the area and applying new seed and mulch.
- If the vegetated cover is less than 80%, the area shall be reseeded.

C.2.9 Mulch

Mulch can be used as an aid to control erosion on critical sites during land clearing and periods of construction when re-vegetation is not practical. The best results are obtained from double shredded (2 - 4 inch) mulch. The most common uses are as berms at the bottom of long, steep slopes and as a blanket in channels where designed flow does not exceed 3.5 feet per second; on interceptor swales and diversion dikes when design flow exceeds 6 feet per second; and on long slopes where rill erosion hazard is high and planting is likely to be slow to establish adequate protective cover.

Materials:

Mulch is easily obtained as a by-product of land clearing operations. It can also be a cost saving item because it is a recycled material and may be suitable for incorporating into the final vegetation/ landscape.

Inspection and Maintenance Guidelines:

- Mulch shall be inspected weekly and after each rain event to locate and repair any erosion.
- Erosion from storms or other damage shall be repaired as soon as practical by applying new layers of mulch.

C.2.10 Blankets and Matting

Blankets and matting material can be used as an aid to control erosion in high velocity areas during the establishment period of protective vegetation. The most common uses are: in channels, interceptor swales and diversion dikes where designed flow exceeds 6 feet per second or where shear stresses exceed erosion resistance of the channel surface; on short, steep slopes where erosion hazard is high, where planting is likely to be slow to establish adequate protective cover; and on stream banks where moving water is likely to wash out new vegetative plantings. Shear stresses are used in selection of the appropriate channel protection. Table C-2 shall be consulted in addition to the referenced

velocity limits to determine the appropriate level of armoring for a channel, swale or dike

Blankets and matting can also be used to create erosion stops on steep, highly erodible watercourses. Erosion stops shall be placed approximately 3 feet down channel from point of entry of a concentrated flow such as from culverts, tributary channels or diversions or at points where a change in gradient or course of channel occurs. Spacing of erosion stops on long slopes will vary, depending on the erodibility of the soil and velocity and volume of flow.

Biodegradable rolled erosion control products (RECPs) are typically composed of jute fibers, curled wood fibers, straw, coconut fiber, or a combination of these materials. In order for an RECP to be considered 100% biodegradable, the netting, sewing or adhesive system that holds the biodegradable mulch fibers together must also be biodegradable.

Non-biodegradable RECPs are typically composed of polypropylene, polyethylene, nylon or other synthetic fibers. In some cases, a combination of biodegradable and synthetic fibers is used to construct the RECP. Netting used to hold these fibers together is typically non-biodegradable as well.

Materials:

New types of blankets and matting materials are continuously being developed. The Texas Department of Transportation (TxDOT) has defined the critical performance factors for these types of products, and has established minimum performance standards which must be met for any product seeking to be approved for use within any of TxDOT's construction or maintenance activities. The products that have been approved by TxDOT are also appropriate for general construction site stabilization within the City of Round Rock or its ETJ. TxDOT maintains a web site at:

http://www.dot.state.tx.us/business/doing_business/product_evaluation/default.htm

which is continually updated as new products are evaluated.

Installation:

Proper installation of blankets and matting is necessary for these materials to function as intended. They shall always be installed in accordance with the

manufacturer's recommendations. Proper anchoring of the material and preparation of the soil are two of the most important aspects of installation. Typical anchoring methods are shown in Figure 14 and Figure 15.

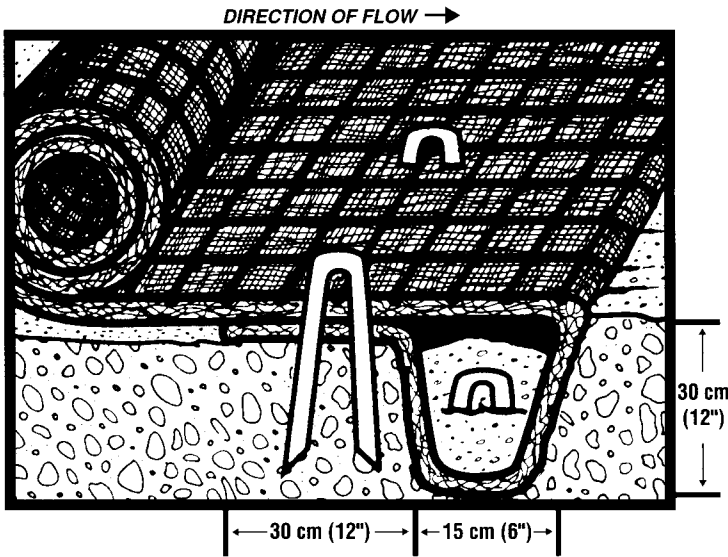

Figure C-14 Typical Initial Anchor Trench for Blankets and Mats

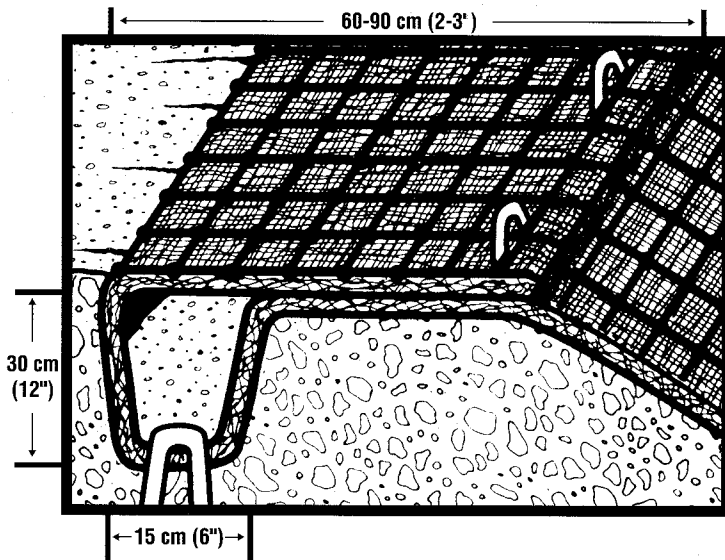

Figure C-15 Typical Terminal Anchor Trench for Blankets and Mats

Soil Preparation and Matting Placement

- After site has been shaped and graded to approved design, prepare a friable seed bed relatively free from clods and rocks more than 1.5 inches in diameter and any foreign material that will prevent contact of the protective mat with the soil surface.
- Fertilize and seed in accordance with seeding or other type of planting plan.
- The protective matting can be laid over sprigged areas where small grass plants have been planted. Where ground covers are to be planted, lay the protective matting first and then plant through matting according to design of planting.
- Install blankets and matting according to manufacturer recommendations considering proper overlapping, direction of flow, and trenching.

Erosion Stops

- Erosion stops shall extend beyond the channel liner to full design cross-section of the channel to check any rills that might form outside the channel lining.
- The trench may be dug with a spade or a mechanical trencher, making sure that the down slope face of the trench is flat; it shall be uniform and perpendicular to line of flow to permit proper placement and stapling of the matting.
- The erosion stop shall be deep enough to penetrate solid material or below level of ruling in sandy soils. In general, erosion stops will vary from 6 to 12 inches in depth.
- The erosion stop mat shall be wide enough to allow a minimum of 2 inch turnover at bottom of trench for stapling, while maintaining the top edge flush with channel surface.
- Tamp backfill firmly and to a uniform gradient of channel.

Final Check:

Make sure:

- All matting is uniformly in contact with the soil.
- All lap joints are secure.
- All staples are flush with the ground.
- All disturbed areas seeded.

Inspection and Maintenance Guidelines:

- Blankets and matting shall be inspected weekly and after each rain event to locate and repair any damage. Apply new material if necessary to restore function.

C.2.11 Organic Compost Mulch

Organic compost mulch consists of applying a mixture of shredded wood fiber, compost and a seed mixture with blowing equipment, which temporarily protects exposed soil from erosion by raindrop impact or wind. Organic compost mulch is suitable for soil disturbed areas requiring temporary protection until permanent stabilization is established, and disturbed areas that will be re-disturbed following an extended period of inactivity. It is not appropriate for use in creeks or waterways, but can be used on steep slopes, not exceeding 2H:1V. Compost products specified for use in this application are described in Table C-3. The product's parameters will vary based on whether vegetation will be established on the treated slope.

Only compost products that meet all applicable state and federal regulations pertaining to its production and distribution may be used in this application. Approved compost products must meet related state and federal chemical contaminant (e.g., heavy metals, pesticides, etc.) and pathogen limit standards pertaining to the feedstocks (source materials) in which it is derived.

Materials:

- Very coarse compost shall be avoided if the slope is to be landscaped or seeded as it will make planting and crop establishment more difficult.
- In regions subject to higher rates of precipitation and/or rainfall intensity, higher compost application rates should be used. In these particular regions, as well as regions subject to wind erosion, coarser compost products are preferred.

Notes: Specifying the use of compost products that are certified by the US Composting Council's Seal of Testing (STA) Program (www.compostingcouncil.org) will allow for the acquisition of products that are analyzed on a routine basis, using the specified test methods. STA participants are also required to provide a standard product label to all customers, allowing easy comparison to other products.

Table C-3 Compost Blanket Parameters

Parameters^{1,4}	Reported as (units of measure)	Surface Mulch to be Vegetated	Surface Mulch to be left Un-vegetated
pH ²	pH units	5.0 - 8.5	N/A
Soluble Salt Concentration ² (electrical conductivity)	dS/m (mmhos/cm)	Maximum 5	Maximum 5
Moisture Content	%, wet weight basis	30 – 60	30 – 60
Organic Matter Content	%, dry weight basis	25 – 65	25-100
Particle Size	% passing a selected mesh size, dry weight basis	<ul style="list-style-type: none"> • 3" (75 mm), 100% passing • 1" (25mm), 90% to 100% passing • 3/4" (19mm), 65% to 100%passing • 1/4" (6.4 mm), 0% to 75% passing • Maximum particle length of 6" (152mm) 	<ul style="list-style-type: none"> • 3" (75 mm), 100% passing • 1" (25mm), 90% to 100% passing • 3/4" (19mm), 65% to 100%passing • 1/4" (6.4 mm), 0% to 75% passing • Maximum particle length of 6" (152mm)
Stability ³ Carbon Dioxide Evolution Rate	mg CO ₂ -C per g OM per day	< 8	N/A
Physical Contaminants (man-made inerts)	%, dry weight basis	< 1	< 1

¹ Recommended test methodologies are provided in Test Methods for the Examination of Composting and Compost (TMECC, The US Composting Council)

² Each specific plant species requires a specific pH range. Each plant also has a salinity tolerance rating, and maximum tolerable quantities are known. When specifying the establishment of any plant or turf species, it is important to understand their pH and soluble salt requirements, and how they relate to the compost in use.

³ Stability/Maturity rating is an area of compost science that is still evolving, and as such, other various test methods could be considered. Also, never base compost quality conclusions on the result of a single stability/maturity test.

⁴ Landscape architects and project (field) engineers may modify the allowable compost specification ranges based on specific field conditions and plant requirements.

Installation:

- The following steps shall be taken for the proper installation of compost as a soil blanket for erosion/sediment control on sloped areas.
- Slightly roughen (scarify) slopes and remove large clods, rocks, stumps, roots larger than 2 inches in diameter and debris on slopes where vegetation is to be established. This soil preparation step may be eliminated where approved by the Project Engineer or Landscape Architect/Designer, or where seeding or planting is not planned. Where practical, track (compact) perpendicular to contours on the slope using a bulldozer before applying compost as soil blanket.

- Apply compost at the rates specified in Table C-4.

Table C-4 Compost Blanket Application Rates

Annual Rainfall/ Flow Rate	Total Precipitation & Rainfall Erosivity Index	Application Rate For <u>Vegetated*</u> Compost Surface Mulch	Application Rate For <u>Unvegetated</u> Compost Surface Mulch
Low	1-25", 20-90	½ - ¾" (12.5 mm - 19 mm)	1" – 1 ½" (25 mm – 37.5mm)
Average	26-50", 91-200	¾ - 1" (19 mm - 25 mm)	1 ½" – 2" (37 mm – 50 mm)
High	51" and above, 201 and above	1-2" (25 mm - 50 mm)	2-4" (50mm – 100mm)

*these lower application rates should only be used in conjunction with seeding, and for compost blankets applied during the prescribed planting season for the particular region.

Compost blanket application rates should be modified based on specific site (e.g., soil characteristics, existing vegetation) and climatic conditions, as well as particular project related requirements. The severity of slope grade, as well as slope length, will also influence compost application rates.

In regions subjected to higher rates of precipitation and/or rainfall intensity, higher compost application rates should be used. In these regions, as well as those with spring snow melt, and on sites possessing severe grades or long slope lengths, the compost blanket may be used in conjunction with a compost filter berm. The filter berm may be 1-2 feet high (30 cm – 60 cm), by 2-4 feet wide (60 cm – 120 cm), and may be placed at the top or base (or both) of the slope. In these particular regions, as well as regions subject to wind erosion, coarser compost products are also preferred.

In regions subject to lower rates of precipitation and/or rainfall intensity, lower compost application rates may be used.

Note: Specific regions may receive higher rainfall rates, but this rainfall is received through low intensity rainfall events (e.g., the Northwestern U.S.). These regions may use lower compost application rates.

Compost shall be uniformly applied using a pneumatic (blower) unit, or other unit that propels the product directly at the soil surface, thereby preventing water from moving between the soil-compost interface. Thorough watering may be used to improve settling of the compost. Apply compost layer approximately 3 feet (90 cm) over the top of the slope, or overlap it into existing vegetation.

On highly unstable soils, use compost in conjunction with appropriate structural measures.

Dry or hydraulic seeding may be completed following compost application, as required, or during the compost application itself, where a pneumatic unit is used to apply the compost.

Inspection and Maintenance Guidelines:

- Mulched areas shall be inspected weekly and after each rain event to locate and repair any damage.

C.2.12

Hydraulic Mulch

Hydraulic mulch consists of applying a mixture of shredded wood fiber or a hydraulic matrix, and a stabilizing emulsion or tackifier with hydro-mulching equipment, which temporarily protects exposed soil from erosion by raindrop impact or wind. Hydraulic mulch is suitable for soil disturbed areas requiring temporary protection until permanent stabilization is established, and disturbed areas that will be re-disturbed following an extended period of inactivity. Seed may be added to the mulch for temporary or permanent vegetation. It is not appropriate for slopes steeper than 3H:1V or for use in channels.

Wood fiber hydraulic mulches are generally short lived and need 24 hours to dry before rainfall occurs to be effective. A second application may be necessary in order to remain effective for an entire rainy season.

Materials:

- *Hydraulic Mulches:* Wood fiber mulch can be applied alone or as a component of hydraulic matrices. Wood fiber applied alone is typically applied at the rate of 2,000 to 4,000 lb/acre. Wood fiber mulch is manufactured from wood or wood waste from lumber mills or from urban sources.
- *Hydraulic Matrices:* Hydraulic matrices include a mixture of wood fiber and acrylic polymer or other tackifier as binder. Apply as a liquid slurry using a hydraulic application machine (i.e., hydro seeder) at the following minimum rates, or as specified by the manufacturer to achieve complete coverage of the target area: 2,000 to 4,000 lb/acre wood fiber mulch, and 5 to 10% (by weight) of tackifier (acrylic copolymer, guar, psyllium, etc.)
- *Bonded Fiber Matrix:* Bonded fiber matrix (BFM) is a hydraulically applied system of fibers and adhesives that upon drying forms an erosion resistant

blanket that promotes vegetation, and prevents soil erosion. BFMs are typically applied at rates from 3,000 lb/acre to 4,000 lb/acre based on the manufacturer's recommendation. A biodegradable BFM is composed of materials that are 100% biodegradable. The binder in the BFM shall also be biodegradable and shall not dissolve or disperse upon re-wetting. Typically, biodegradable BFMs should not be applied immediately before, during or immediately after rainfall if the soil is saturated. Depending on the product, BFMs typically require 12 to 24 hours to dry to become effective.

Installation:

- Prior to application, roughen embankment and fill areas by rolling with a crimping or punching type roller or by track walking. Track walking shall only be used where other methods are impractical.
- To be effective, hydraulic matrices require 24 hours to dry before rainfall occurs.
- Avoid mulch over spray onto roads, sidewalks, drainage channels, existing vegetation, etc.

Inspection and Maintenance Guidelines:

- Mulched areas shall be inspected weekly and after each rain event to locate and repair any damage.
- Areas damaged by storms or normal construction activities shall be regraded and hydraulic mulch reapplied as soon as practical.

C.2.13

Sod

Sod is appropriate for disturbed areas which require immediate vegetative covers, or where sodding is preferred to other means of grass establishment. Locations particularly suited to stabilization with sod are waterways carrying intermittent flow, areas around drop inlets or in grassed swales, and residential or commercial lawns where quick use or aesthetics are factors.

The advantages of properly installed sod include:

- Immediate erosion control.
- An instant green surface with no dust or mud.

- Nearly year-round establishment capability.
- Less chance of failure than seed.
- Freedom from weeds.
- Quick use of the sodded surface.
- The option of buying a quality-controlled product with predictable results.

It is initially more costly to install sod than to seed. However, this cost is justified in places where sod can perform better than seed in controlling erosion. In swales and waterways where concentrated flow will occur, properly pegged sod is preferable to seed because there is no lag time between installation and the time when the channel is protected by vegetation. Drop inlets, which will be placed in grassed areas, can be kept free of sediment, and the grade immediately around the inlet can be maintained, by framing the inlet with sod strips.

Sod can be laid during times of the year when seeded grass may fail, so long as there is adequate water available for irrigation in the early weeks. Ground preparation and proper maintenance are as important with sod as with seed. Sod is composed of living plants and those plants must receive adequate care in order to provide vegetative stabilization on a disturbed area.

Materials:

- Sod shall be machine cut at a uniform soil thickness of 1 inch at the time of cutting. This thickness shall exclude shoot growth and thatch.
- Pieces of sod shall be cut to the supplier's standard width and length, with a maximum allowable deviation in any dimension of 5%. Torn or uneven pads shall not be acceptable.
- Standard size sections of sod shall be strong enough to support their own weight and retain their size and shape when suspended from a firm grasp on one end of the section.
- Sod shall be harvested, delivered, and installed within a period of 36 hours.

Site Preparation:

- Prior to soil preparation, areas to be sodded shall be brought to final grade in accordance with the approved plan.
- The surface shall be cleared of all trash, debris and of all roots, brush, wire, grade stakes and other objects that would interfere with planting, fertilizing or maintenance operations.

- Fertilize according to soil tests. Fertilizer needs can be determined by a soil testing laboratory or regional recommendations can be made by Williamson or Travis County agricultural extension agents. Fertilizer shall be worked into the soil to a depth of 3 inches with a disc, springtooth harrow or other suitable equipment. On sloping land, the final harrowing or discing operation should be on the contour.

General Installation:

- Sod shall not be cut or laid in excessively wet or dry weather. Sod also shall not be laid on soil surfaces that are frozen.
- During periods of high temperature, the soil should be lightly irrigated immediately prior to laying the sod, to cool the soil and reduce root burning and dieback.
- The first row of sod should be laid in a straight line with subsequent rows placed parallel to and butting tightly against each other. Lateral joints should be staggered to promote more uniform growth and strength. Care should be exercised to ensure that sod is not stretched or overlapped and that all joints are butted tight in order to prevent voids which would cause drying of the roots.
- On slopes sod should be laid with staggered joints and secured by stapling or other approved methods. On slopes greater than 3:1 or wherever excessive erosion may be a problem, sod should not be used.
- As sodding of clearly defined areas is completed, sod should be rolled or tamped to provide firm contact between roots and soil.
- After rolling, sod should be irrigated to a depth sufficient that the underside of the sod pad and the soil 4 inches below the sod is thoroughly wet.
- Until such time as a good root system becomes developed, in the absence of adequate rainfall, watering should be performed as often as necessary to maintain moist soil to a depth of at least 4 inches.
- The first mowing should not be attempted until the sod is firmly rooted, usually 2-3 weeks. Not more than one third of the grass leaf should be removed at any one cutting.

Installation in Channels:

- Sod strips in waterways should be laid perpendicular to the direction of flow. Care should be taken to butt ends of strips tightly.

- After rolling or tamping, sod should be pegged or stapled to resist washout during the establishment period. Mesh or other netting may be pegged over the sod for extra protection in critical areas.

Inspection and Maintenance Guidelines:

- Sod should be inspected weekly and after each rain event to locate and repair any damage.
- Damage from storms or normal construction activities such as tire ruts or disturbance of swale stabilization should be repaired as soon as practical.

C.2.14 Dust Control

The purpose of dust control is to: prevent blowing and movement of dust from exposed soil surfaces; reduce on and off-site damage and health hazards; and, improve traffic safety. This practice is applicable to areas subject to dust blowing and movement where on and off-site damage is likely without treatment.

Construction activities inevitably result in the exposure and disturbance of soil. Fugitive dust is emitted both during the activities (i.e., excavation demolition, vehicle traffic, human activity) and as a result of wind erosion over the exposed earth surfaces. Large quantities of dust are typically generated in 'heavy' construction activities, such as road and street construction and subdivision, commercial or industrial development, which involve disturbance of significant areas of the soil surface. Research on construction sites has established an average dust emission rate of 1.2 tons/acre/month for active construction. Earth moving activities comprise the major source of construction dust emissions, but traffic and general disturbance of the soil also generate significant dust emissions.

Temporary Methods:

- Vegetative Cover - See Section C.2.8.
- Mulches - See Section C.2.10 or C.2.13 – Chemical mulch binders may be used to bind mulch material. Commercial binders should be used according to manufacturer's recommendations.
- Commercially available dust suppressors if applied in accordance with the manufacturers' directions.

- Tillage - to roughen surface and bring clods to the surface. This is an emergency measure that should be used before soil blowing starts. Begin plowing on windward side of site. Chisel-type plows spaced about 12 inches apart, spring-toothed harrows and similar plows are examples of equipment that may produce the desired effect.
- Irrigation - Site is sprinkled with water until the surface is moist. Repeat as needed. Irrigation can be particularly effective for controlling dust during trenching operations. A dedicated water truck placed next to the trencher and using a "pulse" fog pattern applied to the discharge belt can effectively control dust. This method is more effective than spraying the ground ahead of the trencher or the trench itself as it is being dug.
- Barriers - Solid board fences, snow fences, burlap fences, crate walls, bales of hay and similar materials can be used to control air currents and soil blowing. Barriers placed at right angles to prevailing currents at intervals of about 15 times their height are effective in controlling soil blowing.

Permanent Methods:

- Permanent Vegetation -- trees or large shrubs may afford valuable protection if left in place.
- Topsoil - Covering with less erosive soil material.
- Stone - Cover surface with crushed stone or coarse gravel.

Inspection and Maintenance Guidelines:

- When dust is evident during dry weather, reapply or repair implemented dust control BMPs and/ or revise dust control plan to implement more effective or appropriate BMPs.

C.3 Sediment Control BMPs

C.3.1 General Guidelines

Construction activities normally result in disturbed/ exposed soil areas due to grading operations, clearing and other activities. Erosion will occur in the disturbed areas and Best Management Practices (BMPs) should be used to contain the sediment transported by storm water runoff. Although the names of many controls suggest that filtration is an important component of sediment removal, almost all reduction in sediment load is the result of particle settling under relatively quiescent conditions. Consequently, sediment barriers, such as

erosion control logs, silt fences, and rock berms, should be designed and installed as temporary (although leaky) dams.

When viewed as temporary dams, it is easier to see the importance of installing these devices along the contour or with a constant top elevation to prevent concentrating the runoff at the lowest spot in the barrier. Concentrating the runoff in this fashion can result in more erosion than if no barrier was installed at all. Therefore, great care should be taken in the placement and installation of these types of controls.

For larger areas or where effective installation of sediment barriers is not an option, sediment traps and sediment basins should be used to control sediment in runoff. These devices are essentially larger, more permanent dams that temporarily detain storm water runoff.

All of the sediment control BMPs are potentially very effective for removing sediment from storm water runoff when properly maintained and installed. However, this potential is often squandered. Casual observation of many active construction sites reveals silt fences that are torn or damaged by equipment, evidence of storm water bypass, or controls installed in inappropriate locations (i.e., silt fences used in channels). In these cases, significant funds are expended for little in the way of water quality protection. Consequently, proper installation and maintenance should form a key component of any temporary sediment control plan.

A list of the temporary sediment controls and their appropriate siting criteria are contained in Table C-5. More detailed guidance on siting and maintenance are contained in the subsequent sections. Note that hay bales are no longer considered an effective sediment control measure. Compost amended soils can be used to promote vegetation growth, but they are not considered a sediment control technology.

Table C-5 Guidelines for Selection of Sediment Control BMPs

Sediment Control	Applications	Drainage Area	Slope	Spacing
Construction Exit	Should be used at all designated access points.	NA	NA	NA
Silt Fence (interior)	Areas of minor sheet flow.	< 2 acres	< 20%	200 ft
Silt Fence (exterior)	Down slope borders of site; up slope border is necessary to divert offsite drainage. For larger areas use diversion swale or berm.	NA	See Table C-6	See Table C-6
Triangular Filter Dike	Areas within site requiring frequent access.	< 1 acre	< 10%	NA
Rock Berm	Drainage swales and ditches with and below site.	< 5 acres	< 30%	See Table C-7
High Service Rock Berm	Around sensitive features, high flow areas within and below site.	< 5 acres	< 30%	See Table C-7
Brush Berm	Small areas of sheet flow	< 2 acres	< 20%	See Table C-7

Vegetative Buffer Strips	On floodplains, next to wetlands, along stream banks, and on steep slopes.	NA	NA	NA
Inlet Protection	Prevent sediment from entering storm drain system.	< 1 acre	NA	NA
Sediment Trap	Used where flows concentrated in a swale or channel	1-5 acres	NA	NA
Sediment Basin	Appropriate for large disturbed areas	5 – 100 acres	NA	NA
Filter Rolls	On slopes to interrupt slope	< 1 acre	<30%	See Table C-7
Dewatering Operations	Used to remove groundwater or accumulated storm water from excavations	NA	NA	NA
Spill Prevention	Used on all sites to reduce spills	NA	NA	NA
Creek Crossings	Crossings of drainage ways and creeks	>5 acres	NA	NA
Concrete Washout	Use on all concrete pouring operations	NA	NA	NA

**Table C-6
Silt Fence Spacing on Sloping Sites**

Slope Angle	Soil Type		
	Silty	Clays	Sandy
Very steep (1:1)	50 ft.	75 ft.	100 ft.
Steep (2:1)	75 ft.	100 ft.	125 ft.
Moderate (4:1)	100 ft.	125 ft.	150 ft.
Slight (10:1)	125 ft.	150 ft.	200 ft.

**Table C-7
Rock and Brush Berm and Erosion Control Logs Spacing on Channels**

Ditch slope	Spacing
30%	10 ft.
20%	15 ft.
15%	20 ft.
10%	35 ft.
5%	55 ft.
3%	100 ft.
2%	150 ft.
1%	300 ft.
0.50%	600 ft.

C.3.2 Stabilized Construction Entrance/Exit

The purpose of a stabilized construction entrance/ exit is to provide a stable entrance/exit condition from the construction site and keep mud and sediment from being deposited from vehicles and equipment onto public roads or other paved areas used by private or public parties. A stabilized construction entrance is a stabilized pad of 3" to 8" stone located at any point traffic will be entering or leaving the construction site from/ to a right-of-way, street, drive, alley, sidewalk or parking area. This practice should be used at all points of construction ingress and egress. See City standard detail for stabilized construction entrance/exit.

Excessive amounts of mud can also present a safety hazard to roadway users. To minimize the amount of sediment loss to nearby roads, access to the construction site should be limited to as few points as possible and vegetation around the perimeter should be protected where access is not necessary. A rock stabilized construction entrance should be used at all designated access points.

Materials:

- The aggregate should consist of 3 to 8 inch washed stone over a stable foundation as specified in the plan.
- The aggregate should be placed with a minimum thickness of 8 inches.
- The geotextile fabric should be designed specifically for use as a soil filtration media with an approximate weight of 4 oz/yd².
- If a washing facility is required, a level area with a minimum of 4 inch diameter washed stone or commercial rack should be included in the plans. Divert wash water to a sediment trap or basin.

Installation:

- Avoid curves on public roads and steep slopes. Remove vegetation and other objectionable material from the foundation area. Grade crown foundation for positive drainage.
- The minimum width of the entrance/exit shall not be less than the full width of ingress/ egress or 12 feet, whichever is greater.
- The construction site entrance should be at least 50 feet long.

- If the slope toward the road exceeds 2%, construct a ridge, 6 to 8 inches high with 3:1 (H:V) side slopes, across the entrance/ exit width approximately 15 feet from the beginning of the entrance to divert runoff away from the public road.
- Place stone to dimensions and grade shown on plans. Leave surface smooth and sloped for drainage.
- Divert all surface runoff and drainage from the stone pad to a sediment trap or basin if necessary.
- Install pipe under pad as needed to maintain proper public road drainage.

Common trouble points

- Inadequate runoff control – sediment washes onto public road or other paved area.
- Stone too small resulting in muddy condition as stone is pressed into soil.
- Pad too short for heavy construction traffic – extend pad beyond the minimum 50 foot length as necessary.
- Pad not flared sufficiently at road intersection, results in mud being tracked on to road and possible damage to road edge.
- Pad not turned or raked after a period of time.
- Existing curbs damaged and not properly protected.
- Rocks displaced onto roadway and not cleaned up.

Inspection and Maintenance Guidelines:

- The entrance should be maintained in a condition which will prevent tracking or flowing of sediment onto public rights-of-way. This may require periodically turning the top dressing with additional stone as conditions demand and repair and/or cleanout of any measures used to trap sediment.
- All sediment spilled, dropped, washed or tracked onto rights-of-way or other paved areas outside of the construction site shall be removed immediately by contractor.

- When necessary, wheels should be cleaned to remove sediment prior to exiting the construction site.
- When washing is required, it should be done on an area stabilized with crushed stone that drains into an approved sediment trap or sediment basin.
- All sediment should be prevented from entering any storm drain, ditch or water course by using approved methods.

C.3.3 Silt Fence

A silt fence is a barrier consisting of geotextile fabric supported by metal posts to prevent soil and sediment loss from a site. When properly used, silt fences can be highly effective. They help runoff to pond, allowing heavier solids to settle out. See the City's standard silt fence detail.

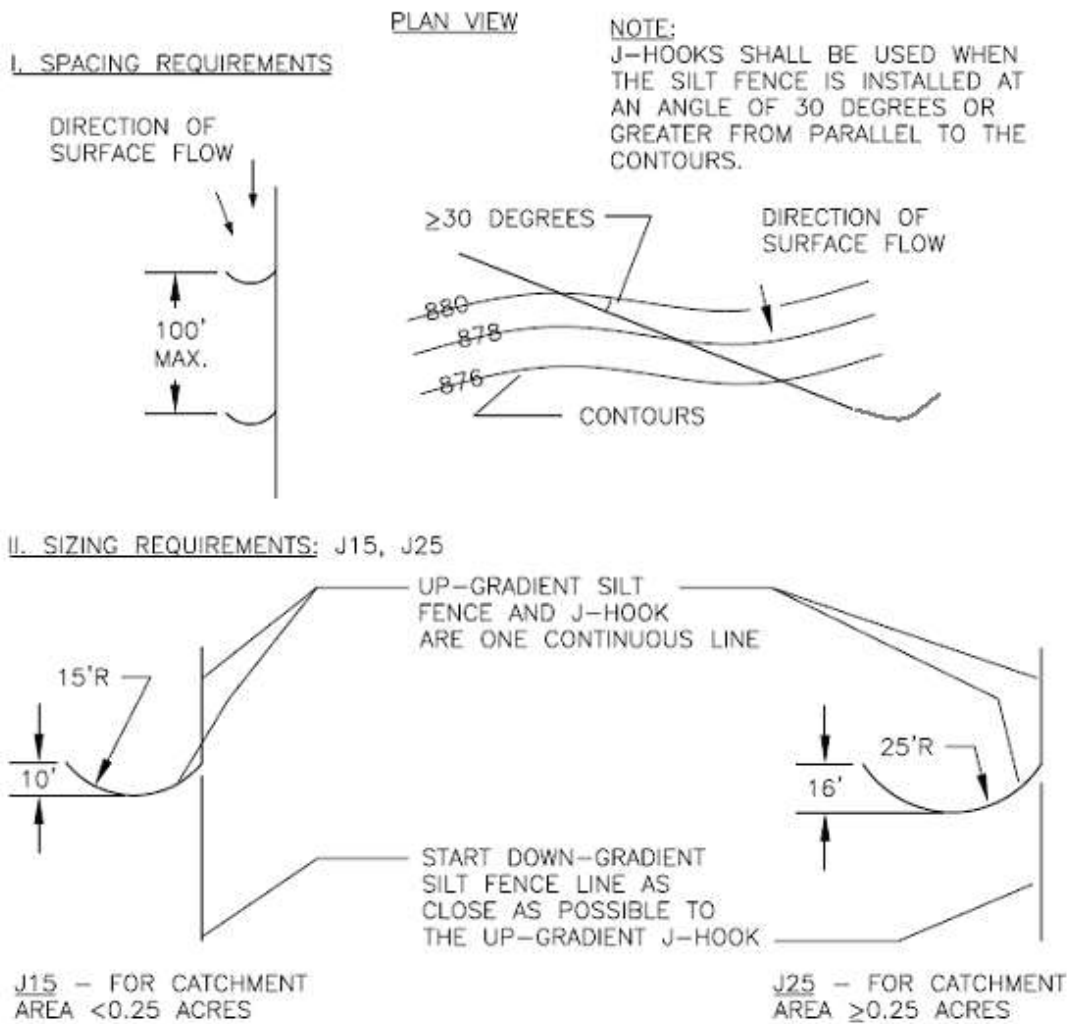

Figure C-16 Schematic J-hook Placement

The purpose of a silt fence is to intercept and prevent further transport of water-borne sediment from unprotected areas of a limited extent. Silt fence is used during construction near the perimeter of a disturbed area to intercept sediment while allowing water to percolate through. This fence should remain in place until the disturbed area is permanently stabilized. Silt fence should not be used where there is a concentration of water in a channel or drainage way. If concentrated flow occurs after installation, corrective action must be taken such as placing a rock berm in the areas of concentrated flow.

Silt fencing within the site may be temporarily moved during the day to allow construction activity provided it is replaced and properly anchored to the ground at the

end of the day or prior to a rain event. Silt fences on the perimeter of the site or around drainage ways should not be moved at any time.

Use J-hooks to trap and pond runoff flowing along uphill side of silt fence as shown in Figure C-16. This will filter or settle outflows and prevent runoff from escaping around the sides of the fence.

Materials:

- Silt fence material should be nonwoven fabric. The fabric with a minimum unit weight of 4.0 oz/yd.
- Fence posts should be made of hot rolled steel, at least 4 feet long with Tee or Y-bar cross section, surface painted or galvanized.
- Woven wire backing to support the fabric should be galvanized 2" x 4" welded wire, 12 gauge minimum.

Installation:

- Steel posts, which support the silt fence, should be installed on a slight angle toward the anticipated runoff source. Posts must be embedded a minimum of 1-foot deep and spaced not more than 8 feet on center. Where water concentrates, the maximum spacing should be 6 feet.
- Lay out fencing down-slope of disturbed area, following the contour as closely as possible. Utilize J-hooks as necessary as shown in Figure C-16. The fence should be sited so that the maximum drainage area is $\frac{1}{4}$ acre/100 feet of fence.
- The toe of the silt fence should be trenched in with a spade or mechanical trencher, so that the down-slope face of the trench is flat and perpendicular to the line of flow. Where fence cannot be trenched in (e.g., pavement or rock outcrop), weight fabric flap with 3 inches of pea gravel on uphill side to prevent flow from seeping under fence.
- The trench must be a minimum of 6 inches deep and 6 inches wide to allow for the silt fence fabric to be laid in the ground and backfilled with compacted material.
- Silt fence should be securely fastened to each steel support post or to woven wire, which is in turn attached to the steel fence post. There should be a 3-foot overlap, securely fastened where ends of fabric meet.
- Silt fence should be removed when the site is completely stabilized so as not to block or impede storm flow or drainage.

Common Trouble Points:

- Fence not installed along the contour causing water to concentrate and flow over the fence.
- Fabric not seated securely to ground (runoff passing under fence)
- Fence not installed perpendicular to flow line (runoff escaping around sides)
- Fence treating too large an area, or excessive channel flow (runoff overtops or collapses fence)
- Damage to silt fencing not repaired in a timely manner.

Inspection and Maintenance Guidelines:

- Inspect all fencing weekly and after any rainfall in excess of 0.5 inch or more.
- Remove sediment when buildup reaches 6 inches.
- Replace any torn fabric.
- Replace or repair any sections crushed or collapsed in the course of construction activity. If a section of fence is obstructing vehicular access, consider relocating it to a spot where it will provide equal protection, but will not obstruct vehicles. A triangular filter dike may be preferable to a silt fence at common vehicle access points.
- When construction is complete, the sediment should be disposed of in a manner that will not cause additional siltation and the prior location of the silt fence should be revegetated. The fence itself should be disposed of in an approved landfill.

C.3.4 Triangular Sediment Filter Dikes

The purpose of a triangular sediment filter dike is to intercept and prevent further transport of water-borne sediment from unprotected areas of limited extent. The triangular sediment filter dike is used where there is no concentration of water upstream of the dike and the contributing drainage area is less than one acre. If the uphill slope above the dike exceeds 10%, the length of the slope above the dike should be less than 50 feet. If concentrated flow occurs after installation, corrective action should be taken such as placing rock berm in the areas of concentrated flow.

This measure is effective on paved areas where installation of silt fence is not possible or where vehicle access must be maintained. The advantage of these controls is the ease with which they can be moved to allow vehicle traffic, then reinstalled to maintain sediment control.

Materials:

- Silt fence material should be nonwoven fabric. The fabric width should be 36 inches, with a minimum unit weight of 4.0 oz/yd.
- The dike structure should be 6 gauge 6" x 6" wire mesh folded into triangular form being eighteen (18) inches on each side.
- The sand bag material should be polypropylene, polyethylene, polyamide or cotton burlap woven fabric, minimum unit weight 4 oz/yd², mullen burst strength exceeding 300 psi and ultraviolet stability exceeding 70 percent.
- The bag length should be 24 to 30 inches, width should be 16 to 18 inches and thickness should be 6 to 8 inches.
- Sandbags should be filled with coarse grade sand, free from deleterious material. All sand should pass through a No. 10 sieve. The filled bag should have an approximate weight of 40 pounds and stapled or tied with nylon or poly cord.

Installation:

- As shown in the City's standard detail, the frame should be constructed of 6" x 6", 6 gauge welded wire mesh, 18 inches per side, and wrapped with geotextile fabric the same composition as that used for silt fences.
- Filter fabric should lap over ends six (6) inches to cover dike to dike junction; each junction should be secured by shoat rings.
- Position dike parallel to the contours, with the end of each section closely abutting the adjacent sections.
- There are several options for fastening the filter dike to the ground. The fabric skirt may be toed-in with 6 inches of compacted material, or 12 inches of the fabric skirt should extend uphill and be secured with sandbags or a minimum of 3 inches of open graded rock, or with staples

or nails. If these two options are not feasible the dike structure may be trenched in 4 inches.

- Triangular sediment filter dikes should be installed across exposed slopes during construction with ends of the dike tied into existing grades to prevent failure and should intercept no more than one acre of runoff.
- When moved to allow vehicular access, the dikes should be reinstalled as soon as possible, but always at the end of the workday or prior to a rain event.

Common Trouble Points:

- Fabric skirt missing, too short, or not securely anchored (flows passing under dike).
- Gap between adjacent dikes (runoff passing between dikes).
- Dike not placed parallel to contour (runoff flowing around dike).

Inspection and Maintenance Guidelines:

- Inspection should be made weekly and after each rainfall event of greater than 0.5 in. and repair or replacement should be made promptly as required to ensure continued effectiveness.
- Inspect and realign dikes as needed to prevent gaps between sections.
- Accumulated silt should be removed after it reaches a depth of 6 inches, and disposed of in a manner which will not cause additional siltation.
- After the site is completely stabilized, the dikes and any remaining silt should be removed. Silt should be disposed of in a manner that will not contribute to additional siltation.

C.3.5 Tire Washing Facility

The tire washing facility is used in conjunction with a stabilized construction entrance to provide an area where truck wheels and undercarriages can be cleaned prior to traversing the stabilized construction entrance/ exit and entering the public road system. A tire wash may consist of an impervious area or grate over a swale. Wash water from hand held pressure washers or fixed nozzles is collected and drained to a sediment trapping device

such as a stone outlet sediment trap or sediment basin to provide for removal of sediment prior to discharge.

Tire washing should be used on large jobs where there is significant truck traffic, on those sites where site conditions cause the stabilized construction entrance/ exit to be overloaded with sediment and become ineffective and in those instances where contaminated solids might be present on site. They provide added protection and reduce the need to remove sediment from streets and should be considered an ancillary component to the stabilized construction entrance/ exit.

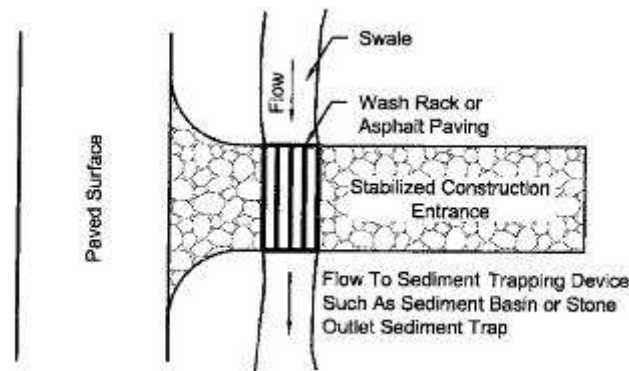

Figure C-17 Schematic Tire Wash Facility

Installation

- The location should be within the stabilized construction entrance/ exit so that the vehicle does not pick up additional sediment load by traversing disturbed areas.
- The size of the tire wash facility should be sufficient so that all wash water and sediment is collected and drained to a sediment trapping device such as a sediment basin or stone outlet sediment trap.
- A tire wash facility design may consist of many different types of materials or configuration as long as it provides the intended function. Suggested designs are:
 - 4 inch thick asphalt pavement on an 8 inch base of crushed rock graded so that wash water drains to a swale; or
 - Grate suitably designed to support construction vehicles installed over a swale.
- The tire wash facility should be designed so that it can be cleaned between uses.

Maintenance

- Wheel wash facilities should be inspected at the end of each shift or workday for damage or repair.
- The surface of the wheel wash should be cleaned between vehicles as necessary.
- Sediment that has accumulated in the wash water sedimentation BMP (sediment trap, sediment basin, etc.) must be removed when it reaches a depth of approximately 1/3 the design depth of the device or 12", whichever is less.
- The removed sediment shall be stockpiled or redistributed in areas that are protected from erosion.
- Remove any mud tracked onto adjacent roadway by sweeping or scraping as necessary.

Inspection Checklist

- Vehicles are leaving the site through designated construction entrance(s) / exit(s).
- Mud, dust or dirt is removed prior to exit onto the adjacent road.
- The construction entrance/ exit is sufficiently maintained to prevent mud, dirt, fines and dust from being tracked off-site.
- Stones under wash rack have been maintained and free of deleterious materials.

C.3.6 Rock Berms

The purpose of a rock berm is to serve as a check dam in areas of concentrated flow, to intercept sediment-laden runoff, detain the sediment and release the water in sheet flow. The rock berm should be used when the contributing drainage area is less than 5 acres. Rock berms are used in areas where the volume of runoff is too great for a silt fence to contain. They are less effective for sediment removal than silt fences, particularly for fine particles, but are able to withstand higher flows than a silt fence. As such, rock berms are often used in areas of channel flows (ditches, gullies, etc.). Rock berms are most effective at reducing bed load in channels and should not be substituted for other erosion and sediment control measures farther up the watershed.

Materials:

- The berm structure should be secured with a woven wire sheathing having maximum opening of 1 inch and a minimum wire diameter of 20 gauge galvanized and should be secured with shoat rings.

- Clean, open graded 3- to 5-inch diameter rock should be used, except in areas where high velocities or large volumes of flow are expected, where 5- to 8-inch diameter rocks may be used.

Installation:

- Lay out the woven wire sheathing perpendicular to the flow line. The sheathing should be 20 gauge woven wire mesh with 1 inch openings.
- Berm should have a top width of 2 feet minimum with side slopes being 2:1 (H:V) or flatter.
- Place the rock along the sheathing as shown in the diagram (Figure C-18), to a height not less than 18”.
- Wrap the wire sheathing around the rock and secure with tie wire so that the ends of the sheathing overlap at least 2 inches, and the berm retains its shape when walked upon.
- Berm should be built along the contour at zero percent grade or as near as possible.
- The ends of the berm should be tied into existing upslope grade and the berm should be buried in a trench approximately 3 to 4 inches deep to prevent failure of the control.
- Follow Table C-7 Rock Berm Spacing on Channels.

Common Trouble Points:

- Insufficient berm height or length (runoff quickly escapes over the top or around the sides of berm)
- Berm not installed perpendicular to flow line (runoff escaping around one side)
- Damage not repaired in a timely manner causing erosion of or around rock berm.

Inspection and Maintenance Guidelines:

- Inspection should be made weekly and after each rainfall by the responsible party. For installations in streambeds, additional daily inspections should be made.
- Remove sediment and other debris when buildup reaches 6 inches and dispose of the accumulated silt in an approved manner that will not cause any additional siltation.
- Repair any loose wire sheathing.
- The berm should be reshaped as needed during inspection.
- The berm should be replaced when the structure ceases to function as intended due to silt accumulation among the rocks, washout, construction traffic damage, etc.
- The rock berm should be left in place until all upstream areas are stabilized and accumulated silt removed.

C.3.7 High Service Rock Berms

A high service rock berm should be designated in areas of important environmental significance such as in steep canyons or above permanent springs, pools, recharge features, or other environmentally sensitive areas that may require a higher level of protection. This type of sediment barrier combines the characteristics of a silt fence and a rock berm to provide a substantial level of sediment reduction and a sturdy enough barrier to withstand higher flows. The drainage area to this device should not exceed 5 acres and the slope should be less than 30%.

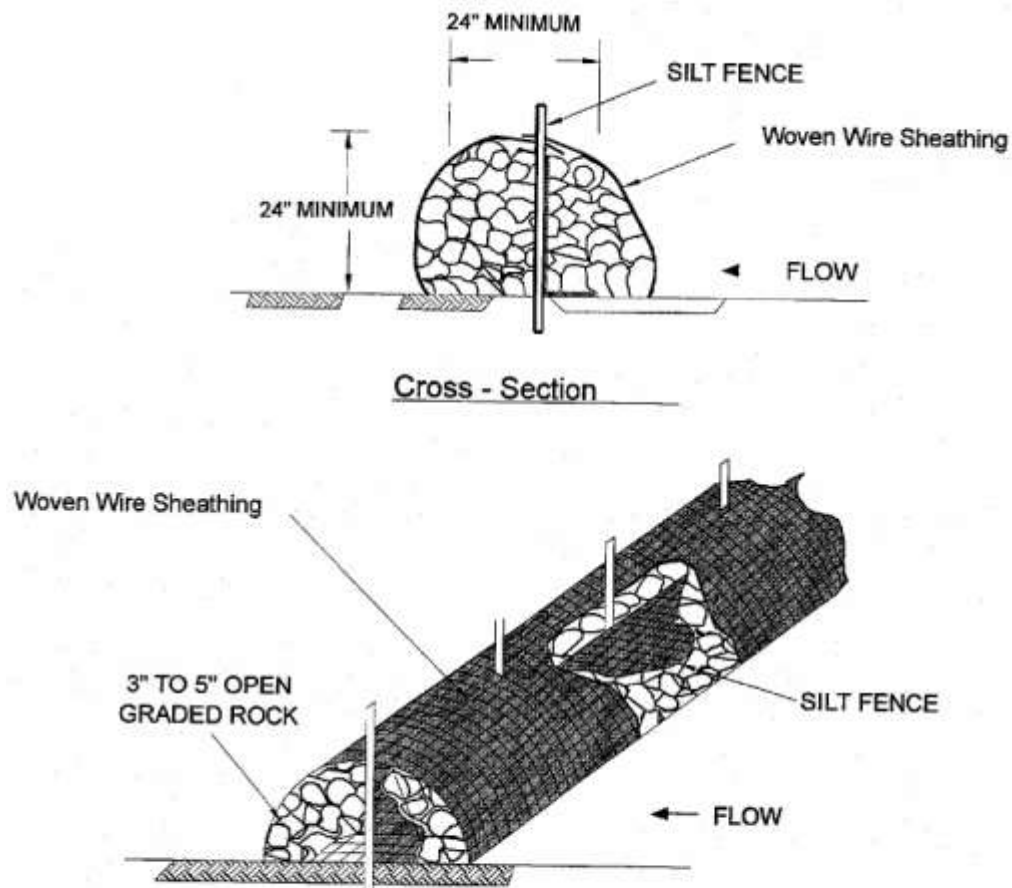

Figure C-19 Schematic Diagram of High Service Rock Berm

Materials:

- Silt fence material should be nonwoven fabric. The fabric width should be 36 inches, with a minimum unit weight of 4.0 oz/yd².
- Fence posts should be made of hot rolled steel, at least 4 feet long with Tee or Y-bar cross section, surface painted or galvanized, minimum nominal weight 1.25 lb/ft², and Brindell hardness exceeding 140. Rebar (either #5 or #6) may also be used to anchor the berm.
- Woven wire backing to support the fabric should be galvanized 2" x 4" welded wire, 12 gauge minimum.

- The berm structure should be secured with a woven wire sheathing having maximum opening of 1 inch and a minimum wire diameter of 20 gauge galvanized and should be secured with shoat rings.
- Clean, open graded 3- to 5-inch diameter rock should be used, except in areas where high velocities or large volumes of flow are expected, where 5- to 8-inch diameter rocks may be used.

Installation:

- Lay out the woven wire sheathing perpendicular to the flow line. The sheathing should be 20 gauge woven wire mesh with 1-inch openings.
- Install the silt fence along the center of the proposed berm placement, as with a normal silt fence described in Section C.3.3.
- Place the rock along the sheathing on both sides of the silt fence as shown in the diagram (Figure C-19), to a height not less than 24 inches. Clean, open graded 3-5 inch diameter rock should be used, except in areas where high velocities or large volumes of flow are expected, where 5- to 8-inch diameter rock may be used.
- Wrap the wire sheathing around the rock and secure with tie wire so that the ends of the sheathing overlap at least 2 inches, and the berm retains its shape when walked upon.
- The high service rock berm should be removed when the site is revegetated or otherwise stabilized or it may remain in place as a permanent BMP if drainage is adequate.
- Follow spacing guidelines on Table C-7 Rock Berm Spacing on Channels.

Common Trouble Points:

- Insufficient berm height or length (runoff quickly escapes over top or around sides of berm).
- Berm not installed perpendicular to flow line (runoff escaping around one side).
- Internal silt fence not anchored securely to ground (high flows displacing berm).
- When installed in streambeds, they often result in diversion scour, so their use in this setting is not recommended.

Inspection and Maintenance Guidelines:

- Inspection should be made weekly and after each rainfall by the responsible party. For installations in streambeds, additional daily inspections should be made.
- Remove sediment and other debris when buildup reaches 6 inches and dispose of the accumulated silt in an approved manner.
- Repair any loose wire sheathing.
- The berm should be reshaped as needed during inspection.
- The berm should be replaced when the structure ceases to function as intended due to silt accumulation among the rocks, washout, construction traffic damage, etc.
- The rock berm should be left in place until all upstream areas are stabilized and accumulated silt removed.

C.3.8 Brush Berms

Woody brush material from site clearing operations is usually burned or hauled away to be dumped elsewhere. Much of this material can be used effectively for preventing sediment from leaving the construction site. The key to constructing an efficient brush berm is in the method used to obtain and place the brush. It will not be acceptable to simply take a bulldozer and push whole trees into a pile. This method does not assure continuous ground contact with the berm and will allow uncontrolled flows under the berm.

Brush berms may be used where there is little or no concentration of water in a channel or other drainage way above the berm. The size of the drainage area should be no greater than one-fourth of an acre per 100 feet of barrier length; the maximum slope length behind the barrier should not exceed 100 feet; and the maximum slope gradient behind the barrier should be less than 50 percent (2:1). Figure C-20 illustrates a brush berm.

Materials:

- The brush should consist of woody brush and branches less than 2 inches in diameter.
- The filter fabric should conform to the specifications for filter fence fabric.
- The rope should be ¼ inch polypropylene or nylon rope.
- The rope anchors should be 3/8-inch diameter rebar stakes that are 18-inches long.

Guidelines for installation:

- Lay out the brush berm following the contour as closely as possible.
- The brush limbs should be cut and hand placed with the vegetated part of the limb in close contact with the ground. Each subsequent branch should overlap the previous branch providing a shingle effect.
- The brush berm should be constructed in lifts with each layer extending the entire length of the berm before the next layer is started.
- Drive the rope anchors into the ground at approximately a 45 degree angle to the ground. The anchors should be placed alternately on 6 foot centers on both sides of the berm so that there is no more than 6 feet between stakes on any one side of the berm.
- Fasten the rope to the anchors and tighten berm securely to the ground.
- The height of the brush berm should be a minimum of 24" after the securing ropes have been tightened.
- A trench should be excavated 6-inches wide and 4-inches deep along the length of the barrier and immediately uphill from the barrier.
- The filter fabric should be cut into lengths sufficient to lay across the barrier from its up-slope base to just beyond its peak. The lengths of filter fabric should be draped across the width of the barrier with the uphill edge placed in the trench and the edges of adjacent pieces overlapping each other. Where joints are necessary, the fabric should be spliced together with a minimum 6-inch overlap and securely sealed.
- The trench should be backfilled and the soil compacted over the filter fabric
- Set stakes into the ground along the downhill edge of the brush barrier, and anchor the fabric by tying rope from the fabric to the stakes. Drive the

rope anchors into the ground at approximately a 45-degree angle to the ground on 6-foot centers.

- Fasten the rope to the anchors and tighten berm securely to the ground with a minimum tension of 50 pounds.
- The height of the brush berm should be a minimum of 24 inches after the securing ropes have been tightened.

Follow spacing guidelines on Table C- Rock and Brush Berm and Erosion Control Logs Spacing on Channels.

.

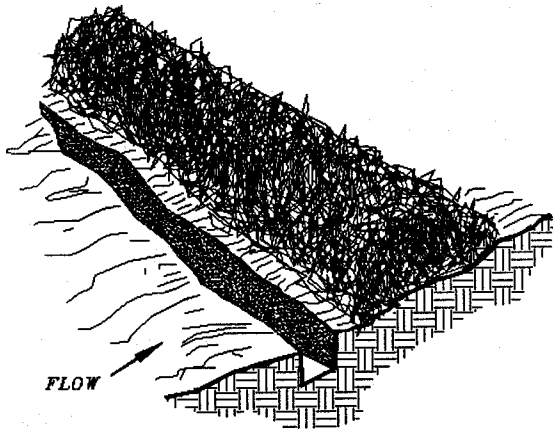

1. EXCAVATE A 4" X 4" TRENCH ALONG THE UPHILL EDGE OF THE BRUSH BARRIER.

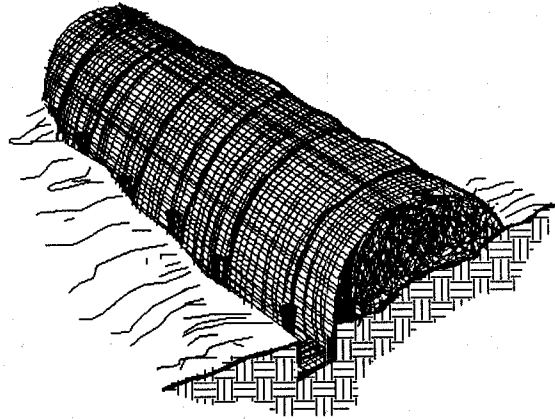

2. DRAPE FILTER FABRIC OVER THE BRUSH BARRIER AND INTO THE TRENCH. FABRIC SHOULD BE SECURED IN THE TRENCH WITH STAKES SET APPROXIMATELY 36" O.C.

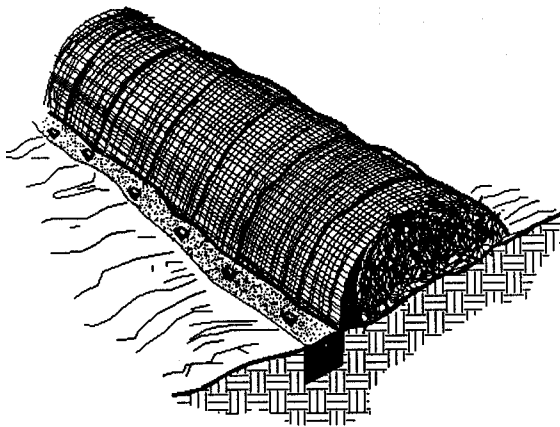

3. BACKFILL AND COMPACT THE EXCAVATED SOIL.

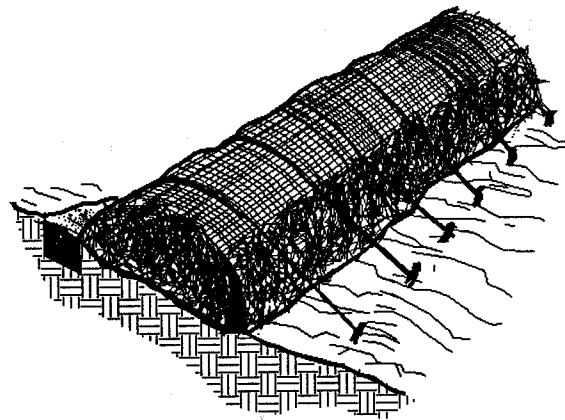

4. SET STAKES ALONG THE DOWNHILL EDGE OF THE BRUSH BARRIER, AND ANCHOR BY TYING TWINE FROM THE FABRIC TO THE STAKES.

Figure C-20 Schematic Diagram of a Brush Berm

Note: Filter fabric may be required in higher velocity situations.

Common Trouble Points:

- Gaps between berm and ground due to uneven ground surface, inadequately compacted berm, or inadequately secured berm (runoff passing directly under berm).
- Berm receiving excessive volumes or velocities of flow (runoff overtopping or displacing berm).

Inspection and Maintenance Guidelines:

- The area upstream from the brush berm should be maintained in a condition that will allow accumulated silt to be removed following the runoff of a rainfall event.
- The berm should be inspected weekly or after each rainfall event.
- When the silt reaches a depth of 6 inches it should be removed and disposed of appropriately and in a manner that will not contribute to additional siltation.
- Periodic tightening of the anchoring ropes may be required due to shrinkage of the brush berm as it deteriorates over time;
- Brush berms should be replaced after 3 months or be repaired or reconstructed when loss of foliage occurs or when they no longer function as intended.

C.3.9 Check Dams

Check dams are small barriers consisting of rock or earthen berms placed across a drainage swale or ditch. They reduce the velocity of small concentrated flows, provide a limited barrier for sediment and help disperse concentrated flows, reducing potential erosion.

They are used primarily in long drainage swales or ditches in which permanent vegetation may not be established and erosive velocities are present. They are typically used in conjunction with other techniques such as inlet protection, riprap or other sediment reduction techniques. Check dams provide limited treatment. They are more useful in reducing flow to acceptable levels for other techniques (NCTCOG, 1993b).

Although check dams are effective in reducing flow velocity and thereby lowering the potential for channel erosion, it is usually better to establish a protective vegetative lining before flow is confined or to install a structural channel lining. However, under circumstances where this is not feasible, check dams are useful.

Materials:

Although many different types of material can be used to create check dams, aggregate and riprap produce a more stable structure.

- If the drainage area is less than 2 acres, coarse aggregate alone can be used for the dam.
- For drainage areas between 2 and 10 acres, a combination of coarse aggregate and riprap as shown in Figure C-21 should be used.

Guidelines for installation:

- The dam height should be between 18 and 36 inches.
- The center of the check dam should be at least 6 inches lower than the outer edges. Field experience has shown that many dams are not constructed to promote this “weir” effect. Storm water flows are then forced to the stone-soil interface, thereby promoting scour at that point and subsequent failure of the structure to perform its intended function.
- The dam should be designed so that the 1-year, 3-hour storm or design storm for the water conveyance, whichever is greater, can pass the dam without causing excessive upstream flooding.
- For added stability, the base of the check dam can be keyed into the soil approximately 6 inches.
- The maximum spacing between the dams should be such that the toe of the upstream dam is at the same elevation as the top of the downstream dam. Follow spacing guidelines on Table C-7 Rock and Brush Berm and Erosion Control Logs Spacing on Channels
- Stone should be placed according to the configuration in Figure C-21. Hand or mechanical placement will be necessary to achieve complete coverage of the ditch or swale and to insure that the center of the dam is lower than the edges.
- Filter cloth may be used under the stone to provide a stable foundation and to facilitate the removal of the stone

2 ACRES OR LESS OF DRAINAGE AREA:

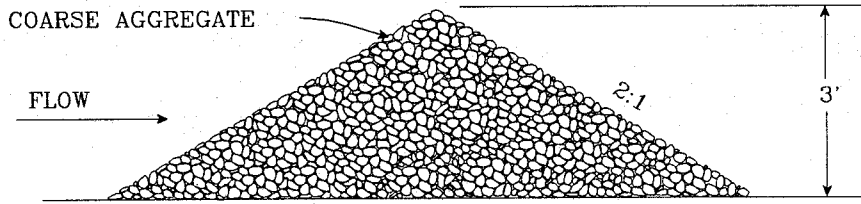
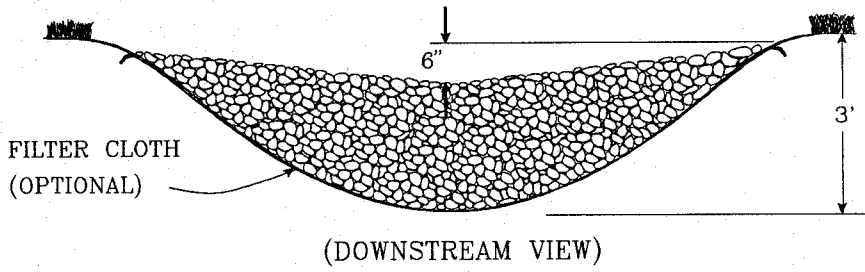

2-10 ACRES OF DRAINAGE AREA:

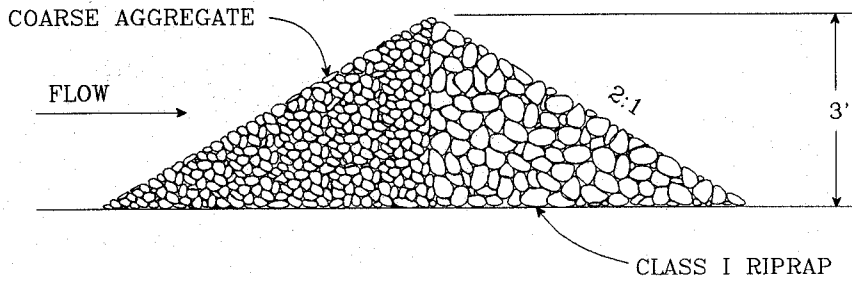
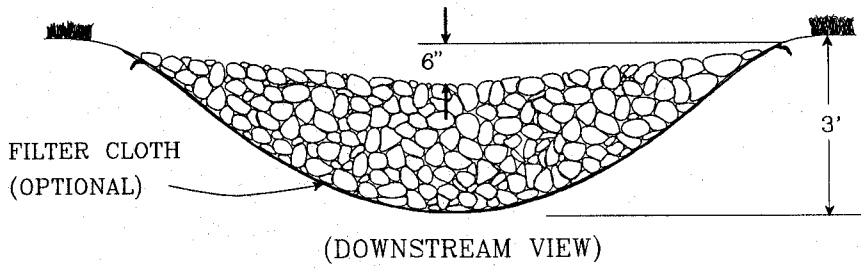

Figure C-21 Schematic Diagram of a Rock Check Dam

Common Trouble Points:

- Check dams installed in grass-lined channels may kill the vegetative lining if submergence after rains is too long and/or silting is excessive.
- If check dams are used in grass-lined channels that will be mowed, care should be taken to remove all the stone when the dam is removed. Stones often wash downstream and can damage mowing equipment and present a safety hazard.

Inspection and Maintenance Guidelines:

- Check dams should be inspected and checked for sediment accumulation weekly and after each runoff-producing storm event.
- Sediment should be removed when it reaches one half of the original height of the measure.
- Regular inspections should be made to insure that the center of the dam is lower than the edges. Erosion caused by high flows around the edges of the dam should be corrected immediately.

C.3.10 Vegetative Buffers

Buffer zones are undisturbed strips of natural vegetation or an established suitable planting that will provide a living filter to reduce soil erosion and runoff velocities from construction activities. Natural buffer zones are used along streams and other bodies of water that need protection from erosion and sedimentation. Vegetative buffers can be used to protect natural swales and be incorporated into natural landscaping of an area. They can provide critical habitat adjacent to streams and wetlands, as well as assisting in controlling erosion, especially on unstable steep slopes.

The buffer zone can be an area of vegetation that is left undisturbed during construction, or it can be newly planted. If buffer zones are preserved, existing vegetation, good planning, and site management are needed to prevent disturbances such as grade changes, excavation, damage from equipment, and other activities. The creation of new buffer strips requires the establishment of a good dense turf (at least 80% coverage) and can include trees and shrubs. The slope cannot exceed 12 percent. The minimum width of a vegetative buffer used for sediment control should be 50 feet.

Guidelines for installation:

- Preserving natural vegetation or plantings in clumps, blocks, or strips is generally the easiest and most successful method.
- All unstable steep slopes should be left in natural vegetation.
- Fence or flag clearing limits and keep all equipment and construction debris out of the natural areas.
- Keep all excavations outside the drip-line of trees and shrubs.
- Debris or extra soil should not be pushed into the buffer zone area because it will cause damage from burying and smothering.
- The minimum width of a vegetative buffer used for sediment control should be 50 feet.

Inspection and Maintenance Guidelines:

Inspection and careful maintenance are important to ensure healthy vegetation. The need for routine maintenance such as mowing, fertilizing, irrigating, and weed and pest control will depend on the species of plants and trees, soil types, location and climatic conditions. County agricultural extension agencies are a good source for this type of information.

C.3.11 Inlet Protection

Storm sewers that are made operational prior to stabilization of the associated capture areas can convey large amounts of sediment to natural drainage ways. In case of extreme sediment loading, the storm sewer itself may clog and lose a major portion of its capacity. To avoid these problems, it is necessary to prevent sediment from entering the system at the inlets. The following guidelines for inlet protection are based primarily on recommendations by the Virginia Dept. of Conservation and Recreation (1992) and the North Central Texas Council of Governments (NCTCOG, 1993b).

In developments for which drainage is to be conveyed by underground storm sewers, all inlets that may receive storm runoff from disturbed areas should be protected. Temporary inlet protection is a series of different measures that provide protection against silt transport or accumulation in storm sewer systems.

This accumulation can greatly reduce or completely stop the flow in the pipes. The different measures are used for different site conditions and inlet types.

Care should be taken when choosing a specific type of inlet protection. Field experience has shown that inlet protection that causes excessive ponding in an area of high construction activity may become so inconvenient that it is removed or bypassed, thus transmitting sediment-laden flows unchecked. In such situations, a structure with an adequate overflow mechanism should be utilized.

It should also be noted that inlet protection devices are designed to be installed on construction sites and not on streets and roads open to the public. **When used on public streets these devices will cause ponding of runoff, which can cause flooding and can present a traffic hazard.** An example of appropriate siting would be a new subdivision where the storm drain system is installed before the area is stabilized and the streets open to the general public. When construction occurs adjacent to active streets, the sediment should be controlled on site and not on public thoroughfares. Occasionally, roadwork or utility installation will occur on public roads. In these cases, inlet protection is an appropriate temporary BMP.

The following inlet protection devices are for drainage areas of one acre or less. Runoff from larger disturbed areas should be routed to a temporary sediment trap or basin.

Filter barrier protection using erosion control logs or silt fence is appropriate when the drainage area is less than one acre and the basin slope is less than five percent. This type of protection is not applicable in paved areas.

Materials:

- Filter fabric should be a nonwoven fabric with a minimum weight of 4.0 oz/yd².
- Erosion control logs should be composed of material as defined in the erosion control log section.
- Posts for erosion control logs or fabric should be 2" x 4" pressure treated wood stakes or galvanized steel, tubular in cross-section or they may be standard fence "T" posts.
- Concrete blocks should be standard 8" x 8" x 16" concrete masonry units.
- Wire mesh should be standard hardware cloth or comparable wire mesh with an opening size not to exceed 1/2 inch.

- The sand bag material should be a minimum unit weight 4 oz/yd², mullen burst strength exceeding 300 psi and ultraviolet stability exceeding 70 percent.

Guidelines for installation:

Silt Fence Area Inlet Protection

- Silt fence should conform to the specifications listed above and should be cut from a continuous roll to avoid joints.
- For stakes, use 2 x 4-inch wood or equivalent metal with a minimum length of 3 feet.
- Space stakes evenly around the perimeter of the inlet a maximum of 3 feet apart, and securely drive them into the ground, approximately 18 inches deep.
- Place the bottom 12 inches of the fabric in a trench and backfill the trench with 12 inches of compacted soil.
- Fasten fabric securely by staples or wire to the stakes and frame. Joints must be overlapped to the next stake.
- It may be necessary to build a temporary dike on the down slope side of the structure to prevent bypass flow.

If the drop inlet is above the finished grade, the grate may be completely covered with filter fabric. The fabric should be securely attached to the entire perimeter of the inlet using 1"x 2" wood strips and appropriate fasteners.

Erosion Control Log Area Inlet Protection

- Erosion control logs should conform to the specifications listed above and should be one continuous roll to minimize overlapping.
- For stakes, use 2 x 4-inch wood or equivalent metal with a minimum length of 3 feet.
- Space stakes evenly around the perimeter of the inlet a maximum of 3 feet apart and securely drive them into the ground, approximately 18 inches deep.

- Fasten fabric securely by staples or wire to the stakes and frame. Joints must be overlapped to the next stake.
- It may be necessary to build a temporary dike on the down slope side of the structure to prevent bypass flow.

Curb Inlet Protection with Silt Fence

- Cut a continuous piece of wire mesh to extend from the top of curb over the inlet opening and along the gutter as shown in the Standard Detail.
- Attach the filter fabric to the wire mesh and cut away a 4 inch clear section near the top of curb to act as a weir.
- Place the assembly against the curb inlet opening and assure the inlet opening is fully covered.
- Place sand bags or alternate weight to weigh down the assembly at the top of curb and in the gutter on each side to assure no movement.
- This type of protection should be inspected frequently and the filter cloth replaced when clogged with sediment.
- Assure that storm flow does not bypass inlet by installing temporary earth or asphalt dikes directing flow into inlet as necessary.

Curb Inlet Protection with Erosion Control Logs

- Place erosion control log in gutter around inlet opening allowing erosion control log to extend 12 inches on either side of opening as shown in the City's Standard Detail. Assure direct contact with surface of gutter flowline.
- Place sandbags between inlet opening and erosion control log to allow for weir flow.
- An erosion control log may be necessary to be placed on the back of curb if site is not stabilized with vegetation.
- This type of protection should be inspected frequently and the erosion control log replaced when clogged with sediment.

C.3.12 Stone Outlet Sediment Trap

A stone outlet sediment trap is an impoundment created by the placement of an earthen and stone embankment to prevent soil and sediment loss from a site. The purpose of a sediment trap is to intercept sediment-laden runoff and trap the sediment in order to protect drainage ways, properties and rights of way below the sediment trap from sedimentation. A sediment trap is usually installed at points of discharge from disturbed areas. The drainage area for a sediment trap is recommended to be less than 5 acres. Larger areas should be treated using a sediment basin. A sediment trap differs from a sediment basin mainly in the type of discharge structure. A schematic of a sediment trap is shown in Figure C-22.

The trap should be located to obtain the maximum storage benefit from the terrain, for ease of cleanout and disposal of the trapped sediment and to minimize interference with construction activities. The volume of the trap should be at least 1800 cubic feet per acre of drainage area.

Materials:

- All aggregate should be at least 3 inches in diameter and should not exceed a volume of 0.5 cubic foot.
- The geotextile fabric specification should be woven polypropylene, polyethylene or polyamide geotextile, minimum unit weight of 4.0 oz/yd², mullen burst strength at least 250 lb/in², ultraviolet stability exceeding 70%, and equivalent opening size exceeding 40.

Installation:

- **Earth Embankment:** Place fill material in layers not more than 8 inches in loose depth. Before compaction, moisten or aerate each layer as necessary to provide the optimum moisture content of the material. Compact each layer to 95 percent standard proctor density. Do not place material on surfaces that are muddy or frozen. Side slopes for the embankment are to be 3:1. The minimum width of the embankment should be 3 feet.
- A gap is to be left in the embankment in the location where the natural confluence of runoff crosses the embankment line. The gap is to have a width in feet equal to 6 times the drainage area in acres.
- **Geotextile Covered Rock Core:** A core of filter stone having a minimum height of 1.5 feet and a minimum width at the base of 3 feet should be placed across the opening of the earth embankment and should be

covered by geotextile fabric which should extend a minimum distance of 2 feet in either direction from the base of the filter stone core.

- Filter Stone Embankment: Filter stone should be placed over the geotextile and should have a side slope which matches that of the earth embankment of 3:1 and should cover the geotextile/rock core a minimum of 6 inches when installation is complete. The crest of the outlet should be at least 1 foot below the top of the embankment.

Common Trouble Points:

- Can cause minor flooding upstream of dam, impacting construction operations.
- The cost of construction, availability of materials, and the amount of land required limit the application of this measure.

Inspection and Maintenance Guidelines:

- Inspection should be made weekly and after each rainfall. Check the embankment, spillways, and outlet for erosion damage, and inspect the embankment for piping and settlement. Repair should be made promptly as needed.
- Trash and other debris should be removed after each rainfall to prevent clogging of the outlet structure.
- Sediment should be removed and the trap restored to its original dimensions when the sediment has accumulated to half of the design depth of the trap.
- Sediment removed from the trap should be deposited in an approved spoils area and in such a manner that it will not cause additional siltation.

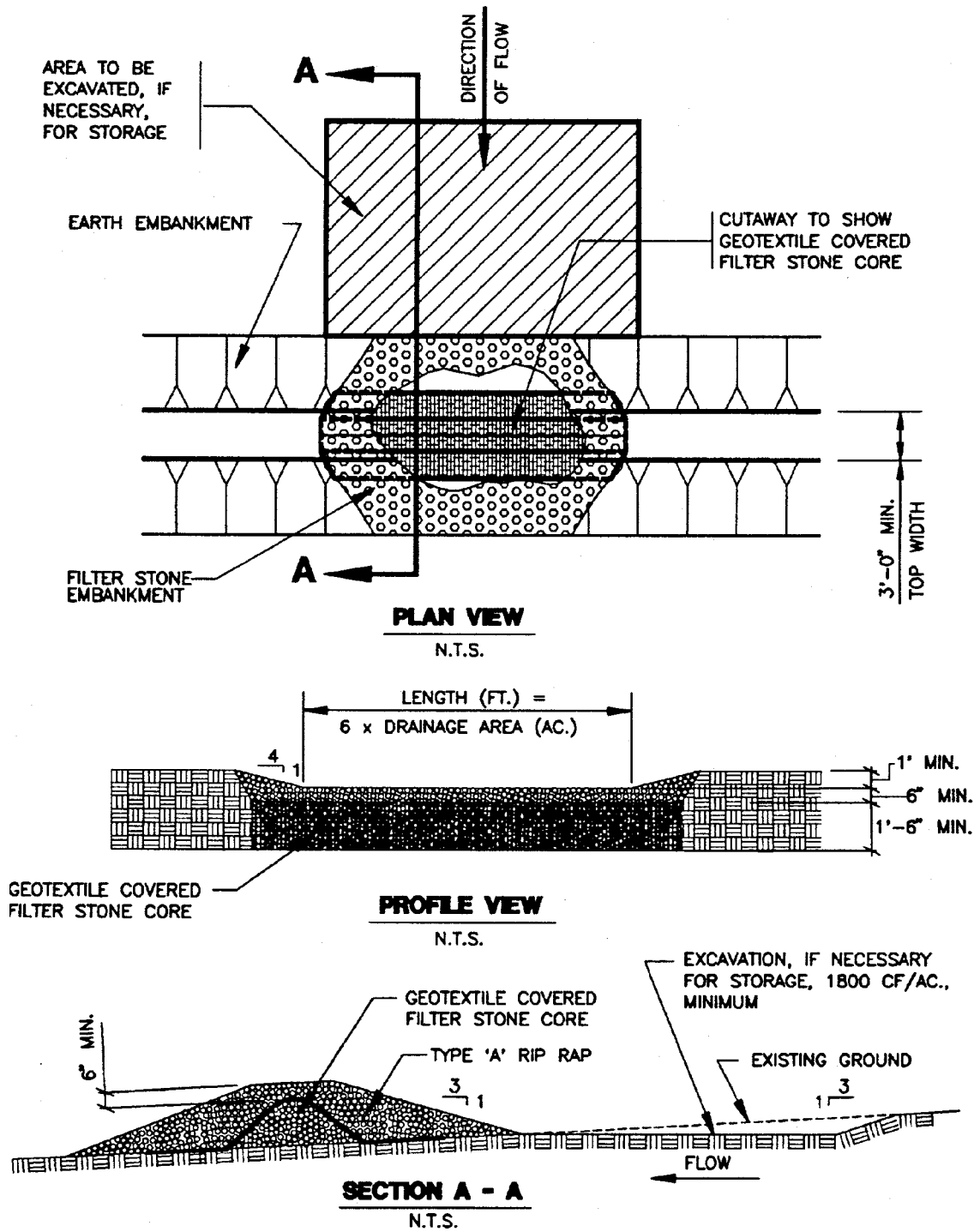

Figure C-22 Schematic Diagram of a Sediment Trap

C.3.13 Sediment Basins

The purpose of a sediment basin is to intercept sediment-laden runoff and trap the sediment in order to protect drainage ways, properties and rights of way below the sediment basin from sedimentation. A sediment basin is usually installed at points of discharge from disturbed areas. The drainage area for a sediment basin is recommended to be less than 100 acres and located off the existing creek or channel.

Sediment basins are effective for capturing and slowly releasing the runoff from larger disturbed areas thereby allowing sedimentation to take place. A sediment basin can be created where a permanent pond BMP is being constructed. Guidelines for construction of the permanent BMP should be followed, but revegetation, placement of underdrain piping, and installation of sand or other filter media should not be carried out until the site construction phase is complete. A schematic of a sediment basin is shown in Figure C-23.

Materials:

- Riser should be corrugated metal or reinforced concrete pipe or box and should have watertight fittings or end to end connections of sections.
- An outlet pipe of corrugated metal or reinforced concrete should be attached to the riser and should have positive flow to a stabilized outlet on the downstream side of the embankment.
- An anti-vortex device and rubbish screen should be attached to the top of the riser and should be made of polyvinyl chloride or corrugated metal.

Basin Design and Construction:

- For common drainage locations that serve an area with ten or more acres disturbed at one time, the sediment basin volume should be 1800 cubic feet of storage for each disturbed acre.
- The basin length to width ratio should be at least 2:1 to improve trapping efficiency. The shape may be attained by excavation or the use of baffles. The lengths should be measured at the elevation of the riser de-watering hole.
- Place fill material in layers not more than 8 inches in loose depth. Before compaction, moisten or aerate each layer as necessary to provide the optimum moisture content of the material. Compact each layer to 95

percent standard proctor density. Do not place material on surfaces that are muddy or frozen. Side slopes for the embankment should be 3:1 (H:V).

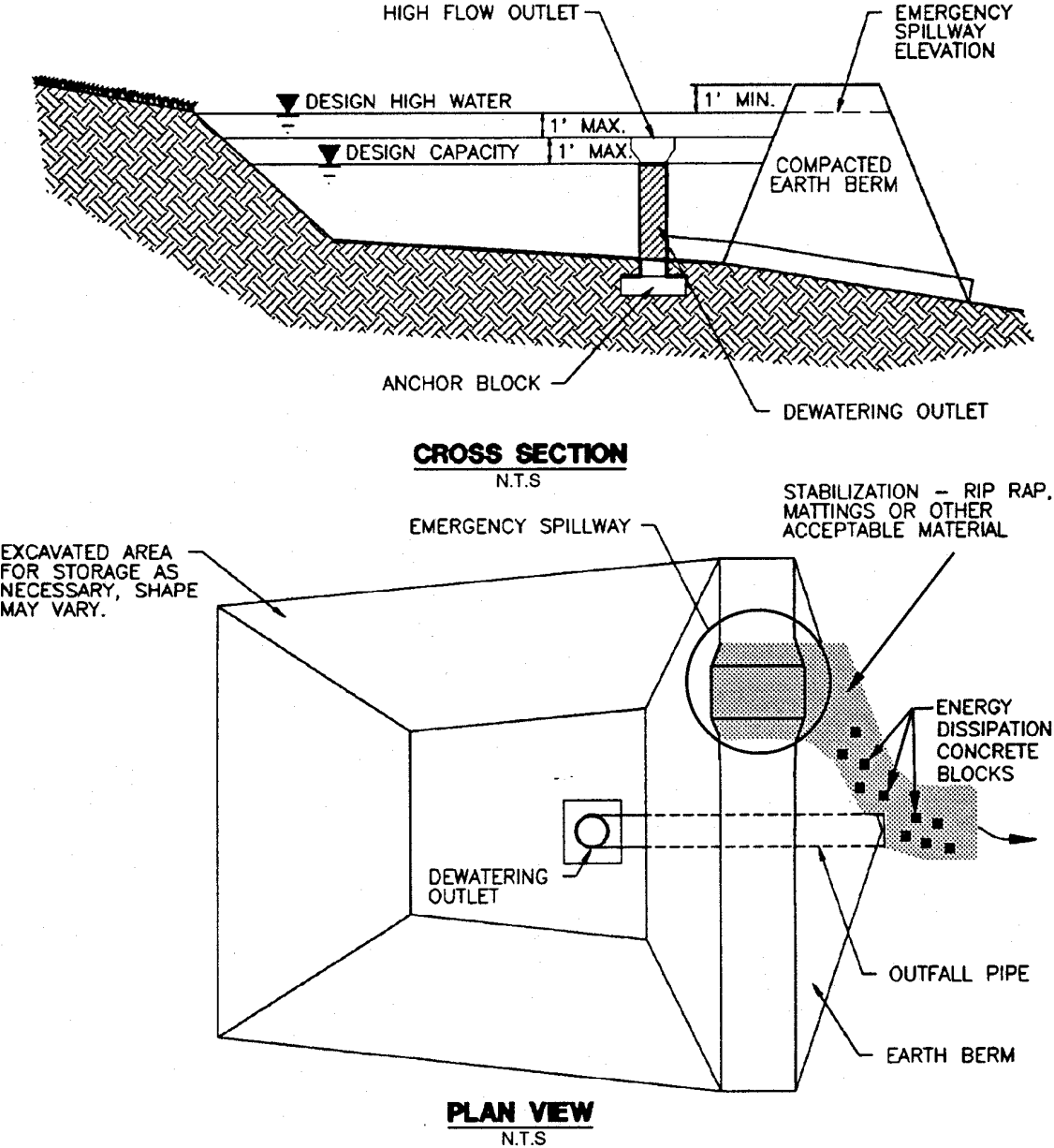

Figure C-23 Schematic of a Sediment Basin

- An emergency spillway should be installed adjacent to the embankment on undisturbed soil and should be sized to carry the full amount of flow generated by a 10-year, 3-hour storm with 1 foot of freeboard less the amount which can be carried by the principal outlet control device.
- The emergency spillway should be lined with riprap as should the swale leading from the spillway to the normal watercourse at the base of the embankment.
- The principal outlet control device should consist of a rigid vertically oriented pipe or box. Attached to this structure should be a horizontal pipe, which should extend through the embankment to the toe of fill to provide a de-watering outlet for the basin.
- An anti-vortex device should be attached to the inlet portion of the principal outlet control device to serve as a rubbish screen.
- A concrete base should be used to anchor the principal outlet control device and should be sized to provide a safety factor of 1.5 (downward forces = 1.5 buoyant forces).
- The basin should include a permanent stake to indicate the sediment level in the pool and marked to indicate when the sediment occupies 50% of the basin volume (not the top of the stake).
- The top of the riser pipe should remain open and be guarded with a trash rack and anti-vortex device. The top of the riser should be 12 inches below the elevation of the emergency spillway. The riser should be sized to convey the runoff from the 1-year, 3-hour storm when the water surface is at the emergency spillway elevation. For basins with no spillway the riser must be sized to convey the runoff from the 10-year, 3-hour storm.
- Anti-seep collars should be included when soil conditions or length of service make piping through the backfill a possibility.
- The 48-hour drawdown time will be achieved by using a riser pipe perforated at the point measured from the bottom of the riser pipe equal to $\frac{1}{2}$ the volume of the basin. This is the maximum sediment storage elevation. The size of the perforation may be calculated as follows:

Equation 3. $A_o = [A_s * (2h)^{0.5} / [C_d * 980,000]$

Where: A_o = Area of the de-watering perforation, ft²
 A_s = Surface area of the basin, ft²
 C_d = Coefficient of contraction, approximately 0.6
 h = head of water above the perforation, ft

Perforating the riser with multiple holes with a combined surface area equal to A_o is acceptable.

Common Trouble Points:

- Storm events that exceed the design storm event can cause damage to the spillway structure of the basin and may cause adverse impacts downstream.
- Piping (flow occurring in the fill material) around outlet pipe can cause failure of the embankment.

Inspection and Maintenance Guidelines:

- Inspection should be made weekly and after each rainfall. Check the embankment, spillways, and outlet for erosion damage, and inspect the embankment for piping and settlement. Repair should be made promptly as needed by the contractor.
- Trash and other debris should be removed after each rainfall to prevent clogging of the outlet structure.
- Accumulated silt should be removed and the basin should be re-graded to its original dimensions at such point that the capacity of the impoundment has been reduced to 75% of its original storage capacity.
- The removed sediment should be stockpiled or redistributed in areas that are protected from erosion.

C.3.14 Erosion Control Logs

An erosion control log consists of wood excelsior, coconut fibers, mulch, or other similar materials bound into a tight tubular roll. When erosion control logs are placed at the toe and on the face of slopes, they intercept runoff, reduce its flow velocity, release the runoff as sheet flow, and provide removal of sediment from the runoff. By interrupting the length of a slope, erosion control logs can also reduce erosion.

Erosion control logs may be suitable:

- Along the toe, top, face, and at grade breaks of exposed and erodible slopes to shorten slope length and spread runoff as sheet flow
- At the end of a downward slope where it transitions to a steeper slope
- Along the perimeter of a project
- As check dams in unlined ditches
- Down-slope of exposed soil areas
- Around temporary stockpiles

Limitations:

- Erosion control logs at the toe of slopes greater than 5:1 (H:V) should be a minimum of 20 in. diameter or installations achieving the same protection (i.e. stacked smaller diameter erosion control logs, etc.).
- Difficult to move once saturated.
- If not properly staked and trenched in, erosion control logs could be transported by high flows.
- Erosion control logs have a very limited sediment capture zone.
- Erosion control logs should not be used on slopes subject to creep, slumping, or landslide.

Material:

- Core material: Core material should be biodegradable or recyclable. Material may be compost, mulch, aspen wood fibers, chipped site vegetation, agricultural rice or wheat straw, coconut fiber, 100% recyclable fibers, or similar materials.
- Containment Mesh: Containment mesh should be 100% biodegradable, photodegradable or recyclable such as burlap, twine, UV photodegradable plastic, polyester, or similar material. When the erosion control log will remain in place as part of a vegetative system use biodegradable or photodegradable mesh. For temporary installation recyclable mesh is recommended.

Implementation:

- Locate erosion control logs on level contours spaced as follows:
- Slope inclination of 4:1 (H:V) or flatter: Erosion control logs should be placed at a maximum interval of 20 ft.

- Slope inclination between 4:1 and 2:1 (H:V): Erosion control logs should be placed at a maximum interval of 15 ft. (a closer spacing is more effective).
- Slope inclination 2:1 (H:V) or greater: Erosion control logs should be placed at a maximum interval of 10 ft. (a closer spacing is more effective).
- Turn the ends of the erosion control log up slope to prevent runoff from going around the roll.
- Stake erosion control logs into a 2 to 4 in. deep trench with a width equal to the diameter of the erosion control log.
- Drive stakes at the end of each erosion control log and spaced 4 ft maximum on center.
- Use wood stakes with a nominal classification of 2" by 2" and minimum length of 24 in.
- If more than one erosion control log is placed in a row, the rolls should be overlapped, not abutted.
- Follow Table C-7 Rock and Brush Berm and Erosion control logs Spacing on Channels.

Inspection and Maintenance Guidelines:

- Inspect prior to rain event, daily during extended rain events, after rain events, and weekly.
- Repair or replace split, torn, unraveling, or slumping erosion control logs.
- If the erosion control log is used as a sediment capture device, or as an erosion control device to maintain sheet flows, sediment that accumulates behind the roll must be periodically removed in order to maintain its effectiveness. Sediment should be removed when the accumulation reaches one-half the designated sediment storage depth, usually one-half the distance between the top of the erosion control log and the adjacent ground surface. Sediment removed during maintenance may be incorporated into earthwork on the site or disposed of at an appropriate location.

C.3.15 Dewatering Operations

Dewatering operations are practices that manage the discharge of pollutants when non-storm water and accumulated precipitation or groundwater must be removed from a work location so that construction work may be accomplished.

The controls detailed in this BMP only allow for minimal settling time for sediment particles and should only be used when site conditions restrict the use of the other control methods. When possible avoid dewatering discharges by using the water for dust control, by infiltration, allowing to evaporate, etc.

A variety of methods can be used to treat water during dewatering operations. Several devices are presented below and provide options to achieve sediment removal. When pumping water out or through any of these devices, a floatation device should be attached to the pump inlet.

Sediment controls are low to high cost measures depending on the dewatering system that is selected. Pressurized filters tend to be more expensive than gravity settling, but are often more effective. Simple tanks are generally rented on a long-term basis (one or more months). Mobilization and demobilization costs vary considerably.

Inspection and Maintenance

- Inspect and verify that activity-based BMPs are in place prior to the commencement of associated activities. While activities associated with the BMP are under way, inspect weekly and after every 0.5 in. or greater rainfall event to verify continued BMP implementation.
- Inspect BMPs subject to non-storm water discharges daily while non-storm water discharges occur.
- Unit-specific maintenance requirements are included with the description of each technology.
- Sediment removed during the maintenance of a dewatering device may be either spread onsite and stabilized, or disposed of at a disposal site.
- Sediment that is commingled with other pollutants must be disposed of in accordance with all applicable laws and regulations.

Weir Tanks

Description:

A weir tank separates water and waste by using weirs. The configuration of the weirs (over and under weirs) maximizes the residence time in the tank and determines the waste to be removed from the water, such as oil, grease, and sediments.

Appropriate Applications:

The tank removes trash, some settleable solids (gravel, sand, and silt), some visible oil and grease, and some metals (removed with sediment). To achieve high levels of flow, multiple tanks can be used in parallel. If additional treatment is desired, the tanks can be placed in series or as pre-treatment for other methods.

Implementation:

- Tanks are delivered to the site by the vendor, who can provide assistance with set-up and operation.
- Tank size will depend on flow volume, constituents of concern, and residency period required. Vendors should be consulted to appropriately size tank.

Maintenance:

- Periodic cleaning is required based on visual inspection or reduced flow.
- Oil and grease disposal must be by licensed waste disposal company.

Dewatering Tanks

Description:

A dewatering tank removes debris and sediment. Flow enters the tank through the top, passes through a fabric filter, and is discharged through the bottom of the tank. The filter separates the solids from the liquids.

Appropriate Applications:

The tank removes trash, gravel, sand, and silt, some visible oil and grease, and some metals (removed with sediment). To achieve high levels of flow, multiple tanks can be used in parallel. If additional treatment is desired, the tanks can be placed in series or as pre-treatment for other methods.

Implementation:

- Tanks are delivered to the site by the vendor, who can provide assistance with set-up and operation.
- Tank size will depend on flow volume, constituents of concern, and residency period required. Vendors should be consulted to determine appropriate size of tank.

Maintenance:

- Periodic cleaning is required based on visual inspection or reduced flow.
- Oil and grease disposal must be by licensed waste disposal company.

Gravity Bag Filter

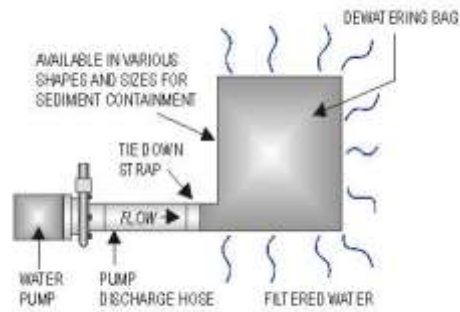

Description:

A gravity bag filter, also referred to as a dewatering bag, is a square or rectangular bag made of non-woven geotextile fabric that collects sand, silt, and fines.

Appropriate Applications:

- Effective for the removal of sediments (gravel, sand, and silt). Some metals are removed with the sediment.

Implementation:

- Water is pumped into one side of the bag and seeps through the bottom and sides of the bag.
- A secondary barrier, such as a rock filter bed or erosion control logs, is placed beneath and beyond the edges of the bag to capture sediments that escape the bag.

Maintenance:

- Inspection of the flow conditions, bag condition, bag capacity, and the secondary barrier is required.
- Replace the bag when it no longer filters sediment or passes water at a reasonable rate. The bag is typically disposed of properly similar to other trash or rubbish.

C.3.16 Spill Prevention and Control

The objective of this section is to describe measures to prevent or reduce the discharge of pollutants to drainage systems or watercourses from leaks and spills by reducing the chance for spills, stopping the source of spills, containing and cleaning up spills, properly disposing of spill materials, and training employees.

The following steps will help reduce the storm water impacts of leaks and spills:

Education

- Be aware that different materials pollute in different amounts. Make sure that each employee knows what a “significant spill” is for each material they use, and what is the appropriate response for “significant” and “insignificant” spills. Employees should also be aware of when spills must be reported to the TCEQ. Information available in 30 TAC 327.4 and 40 CFR 302.4.
- Educate employees and subcontractors on potential dangers to humans and the environment from spills and leaks.
- Hold regular meetings to discuss and reinforce appropriate disposal procedures (incorporate into regular safety meetings).
- Establish a continuing education program to indoctrinate new employees.
- Have contractor’s superintendent or representative oversee and enforce proper spill prevention and control measures.

General Measures

- To the extent that the work can be accomplished safely, spills of oil, petroleum products, substances listed under 40 CFR parts 110,117, and 302, and sanitary and septic wastes should be contained and cleaned up immediately.
- Store hazardous materials and wastes in covered containers and protect from vandalism.
- Place a stockpile of spill cleanup materials where it will be readily accessible and protected from drainage.
- Train employees in spill prevention and cleanup.
- Designate responsible individuals to oversee and enforce control measures.

- Spills should be covered and protected from storm water runoff during rainfall to the extent that it doesn't compromise clean up activities.
- Do not bury or wash spills with water.
- Store and dispose of used clean up materials, contaminated materials, and recovered spill material that is no longer suitable for the intended purpose in conformance with the provisions in applicable BMPs.
- Do not allow water used for cleaning and decontamination to enter storm drains or watercourses. Collect and dispose of contaminated water in accordance with applicable regulations.
- Contain water overflow or minor water spillage and do not allow it to discharge into drainage facilities or watercourses.
- Place Material Safety Data Sheets (MSDS), as well as proper storage, cleanup, and spill reporting instructions for hazardous materials stored or used on the project site in an open, conspicuous, and accessible location.
- Keep waste storage areas clean, well organized, and equipped with ample cleanup supplies as appropriate for the materials being stored. Perimeter controls, containment structures, covers, and liners should be repaired or replaced as needed to maintain proper function.

Cleanup

- Clean up leaks and spills immediately.
- Use a rag for small spills on paved surfaces, a damp mop for general cleanup, and absorbent material for larger spills. If the spilled material is hazardous, then the used cleanup materials are also hazardous and must be disposed of as hazardous waste.
- Never hose down or bury dry material spills. Clean up as much of the material as possible and dispose of properly.

Minor Spills

- Minor spills typically involve small quantities of oil, gasoline, paint, etc. which can be controlled by the first responder at the discovery of the spill.
- Use absorbent materials on small spills rather than hosing down or burying the spill.
- Absorbent materials should be promptly removed and disposed of properly.
- Follow the practice below for a minor spill:
 - Contain the spread of the spill.

- Recover spilled materials.
- Clean the contaminated area and properly dispose of contaminated materials.

Semi-Significant Spills

Semi-significant spills still can be controlled by the first responder along with the aid of other personnel, etc. This response may require the cessation of all other activities.

Spills should be cleaned up immediately:

- Contain spread of the spill.
- Notify the project foreman immediately.
- If the spill occurs on paved or impermeable surfaces, clean up using "dry" methods (absorbent materials, cat litter and/or rags). Contain the spill by encircling with absorbent materials and do not let the spill spread widely.
- If the spill occurs in dirt areas, immediately contain the spill by constructing an earthen dike. Dig up and properly dispose of contaminated soil.
- If the spill occurs during rain, cover spill with tarps or other material to prevent contaminating runoff.

Significant/Hazardous Spills

For significant or hazardous spills that are in reportable quantities:

- Notify the TCEQ by telephone as soon as possible and within 24 hours at 512-339-2929 (Austin) between 8 AM and 5 PM. After hours, contact the Environmental Release Hotline at 1-800-832-8224. It is the contractor's responsibility to have all emergency phone numbers at the construction site.
- For spills of federal reportable quantities, in conformance with the requirements in 40 CFR parts 110, 119, and 302, the contractor should notify the National Response Center at (800) 424-8802.
- Notification should first be made by telephone and followed up with a written report.
- The services of a spills contractor or a Haz-Mat team should be obtained immediately. Construction personnel should not attempt to clean up until the appropriate and qualified staffs have arrived at the job site.

- Other agencies which may need to be consulted include, but are not limited to, the City Police Department, County Sheriff Office, Fire Departments, etc.

More information on spill rules and appropriate responses is available on the TCEQ website at: <http://www.tceq.state.tx.us/response>

Vehicle and Equipment Maintenance

- If maintenance must occur onsite, use a designated area and a secondary containment, located away from drainage courses, to prevent the runoff of storm water and the runoff of spills.
- Regularly inspect onsite vehicles and equipment for leaks and repair immediately
- Check incoming vehicles and equipment (including delivery trucks, and employee and subcontractor vehicles) for leaking oil and fluids. Do not allow leaking vehicles or equipment onsite.
- Always use secondary containment, such as a drain pan or drop cloth, to catch spills or leaks when removing or changing fluids.
- Place drip pans or absorbent materials under paving equipment when not in use.
- Use absorbent materials on small spills rather than hosing down or burying the spill. Remove the absorbent materials promptly and dispose of properly.
- Promptly transfer used fluids to the proper waste or recycling drums. Don't leave full drip pans or other open containers lying around.
- Oil filters disposed of in trashcans or dumpsters can leak oil and pollute storm water. Place the oil filter in a funnel over a waste oil-recycling drum to drain excess oil before disposal. Oil filters can also be recycled. Ask the oil supplier or recycler about recycling oil filters.
- Store cracked batteries in a non-leaking secondary container. Do this with all cracked batteries even if you think all the acid has drained out. If you drop a battery, treat it as if it is cracked. Put it into the containment area until you are sure it is not leaking.

Vehicle and Equipment Fueling

- If fueling must occur on site, use designated areas, located away from drainage courses, to prevent the runoff of storm water and the runoff of spills.
- Discourage "topping off" of fuel tanks.

- Always use secondary containment, such as a drain pan, when fueling to catch spills/ leaks.

C.3.17 Creek Crossings

Creek crossings represent particularly important areas to employ effective erosion and sedimentation control. A temporary stream crossing is used to provide a safe, stable way for construction vehicle traffic to cross a watercourse. Temporary stream crossings provide streambank stabilization, reduce the risk of damage to the streambed or channel, and minimize sediment loading from construction activities and traffic. Underground utility construction and road construction across creeks requires special measures, as detailed below.

General Considerations

- Creek crossings should be made perpendicular to the creek flowline.
- In-stream controls should only be used as a secondary BMP. Storm water runoff approaching a creek crossing should be diverted to a sediment trapping BMP before it reaches the creek.
- If baseflow is present, the City Engineer should be consulted, as it may be necessary to divert or pump water around the construction area.
- Every effort should be made to keep the zone of immediate construction free of surface and ground water. For construction in the creek channel, a pipe of adequate size to divert normal stream flow should be provided around the construction area. Diversion may be by pumping or gravity flow using temporary dams
- Where water must be pumped from the construction zone, discharges should be in a manner that will not cause scouring or erosion. All discharges shall be on the upstream or upslope side of erosion control structures/ measures. If discharges are necessary in easily erodible areas, a stabilized, energy-dissipating discharge apron shall be constructed of riprap with minimum stone diameter of 6 inches and minimum depth of 12 inches. Size of the apron in linear dimensions shall be approximately 10 times the diameter of the discharge pipe.

Utility Crossings & Excavations

- Before any trenching or excavation, install two rock berms at 100-ft spacing across the channel (perpendicular to the flowline) downstream of the proposed trench. These berms should be located between 100 and 300 feet downstream of the proposed trench. Lay pipe or other utility line and bury as soon as possible after trenching.
- After installation is complete (or at the end of work day, if installation cannot be completed by end of day), install erosion control logs or silt

fencing along trench line on either side of creek at 25-ft intervals, as shown in Figure C-24.

- Material excavated from the trench in the creek channel should not be deposited on the channel banks. Excavation should be hauled out of the channel or used in backfill of open trench. No loose excavated material should be left in the channel at the end of a work day.
- A concrete cap should be placed over buried pipe within the creek, and the streambed should be restored to proper grade.
- Revegetate the disturbed area using appropriate native or adapted grass species incorporated with erosion blankets/matting.

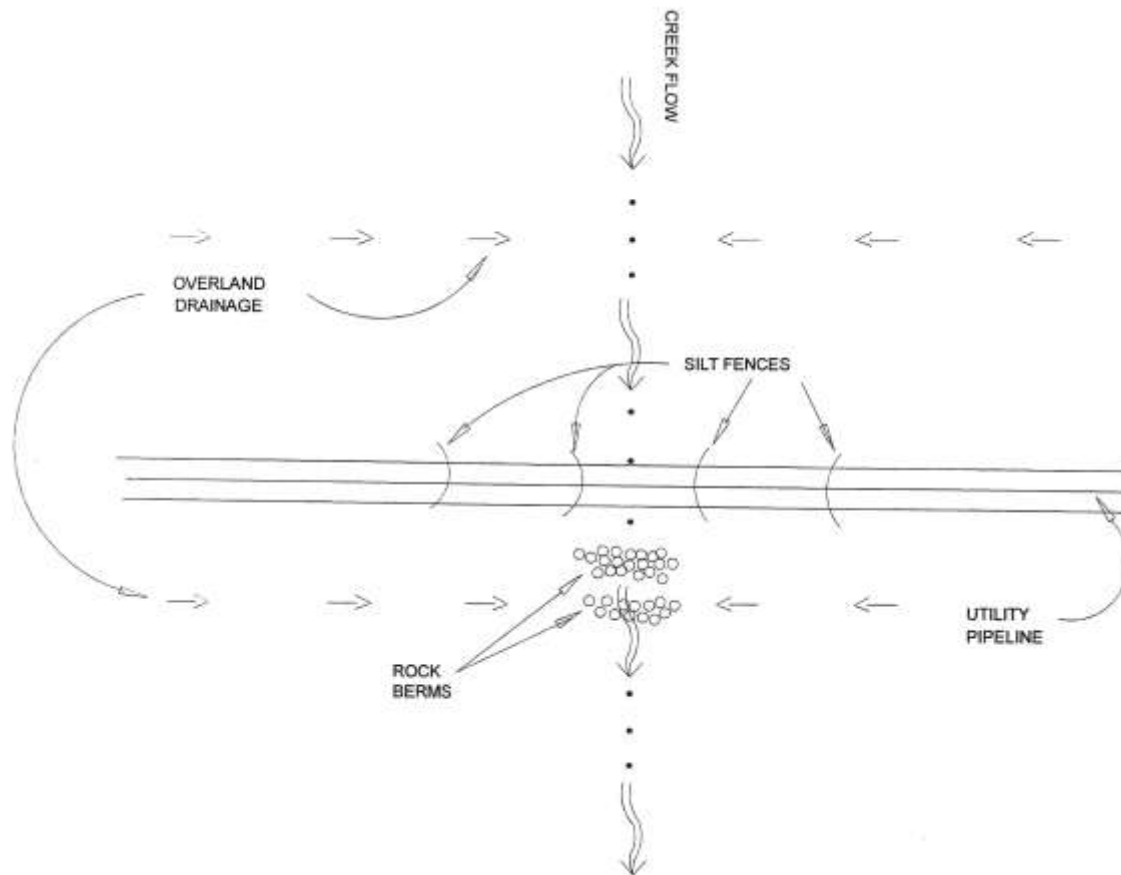

Figure C-24 Utility Crossing or Excavation within Creek Schematic

Road Crossings

A variety of techniques may be used depending on local topography and soil conditions. These include ford crossings, culvert crossings, dragline mats, and bridges.

General Considerations

- Construct temporary crossings at proposed roadway crossings and any additional crossing points. Minimize the number of additional crossings to reduce impact to creeks.
- Where a stream crossing is required, select a crossing site with these features:
 1. Straight and narrow creek channel with high banks;
 2. Stable creek banks that provide solid foundation for a crossing.
 3. Minimal elevation changes (0-10% preferred) on road/trail leading to crossing.

Installation

- Keep heavy equipment out of creek.
- Construct a swale or berm across the approach to the crossing on both sides of the crossing. Other water diversion devices (broad based dips, water bars, etc.) should be used on long approaches to minimize the amount of water flowing to the crossing).
- Stabilize exposed soil around the crossing with mulch, temporary seeding and/or erosion control blankets/matting.

Maintenance

- Keep crossing surface free of soil and debris that could enter stream.
- Check crossing components weekly and after rainfall to maintain strength and integrity.
- Remove large branches or other flow obstructions that could impair the function of the crossing or cause a failure of the crossing.

Removal & Restoration

- Clean off crossing surface; keep debris out of the creek channel.
- Carefully remove crossing materials, minimizing disturbance to the creek channel.
- Permanently stabilize disturbed portions of creek bank and approaches with perennial grasses, erosion control blankets/matting and/or rip rap
- Leave appropriate water diversion structures in place on both sides of creek.

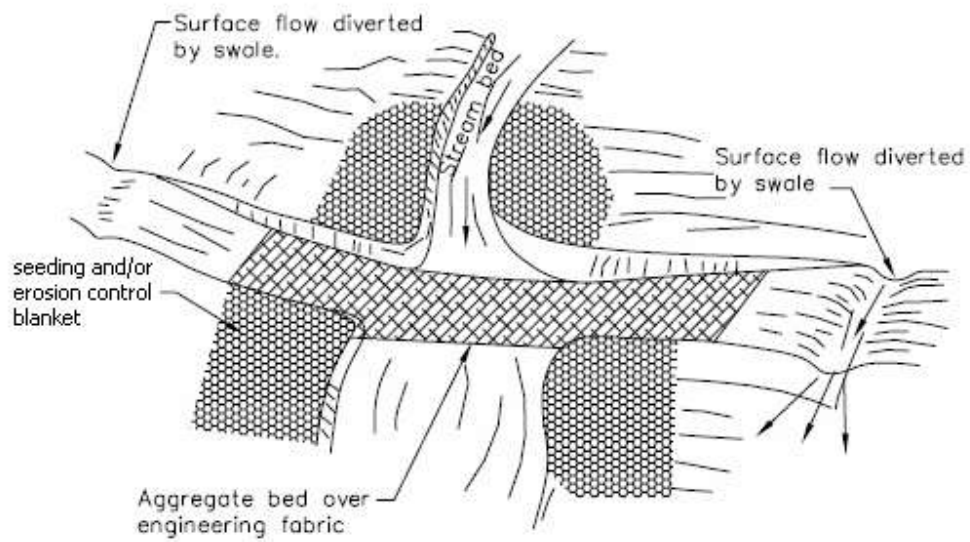

Aggregate approach
1:5 (V:H) Maximum slope on road

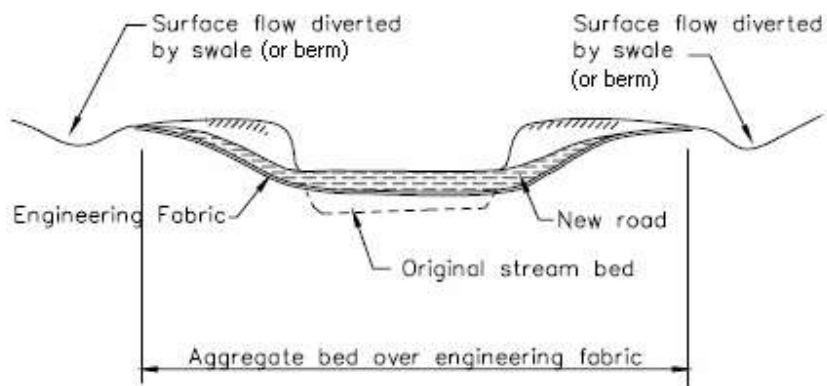

TYPICAL FORD CROSSING
NOT TO SCALE

Figure C-25 Typical Temporary Ford Crossing Schematic

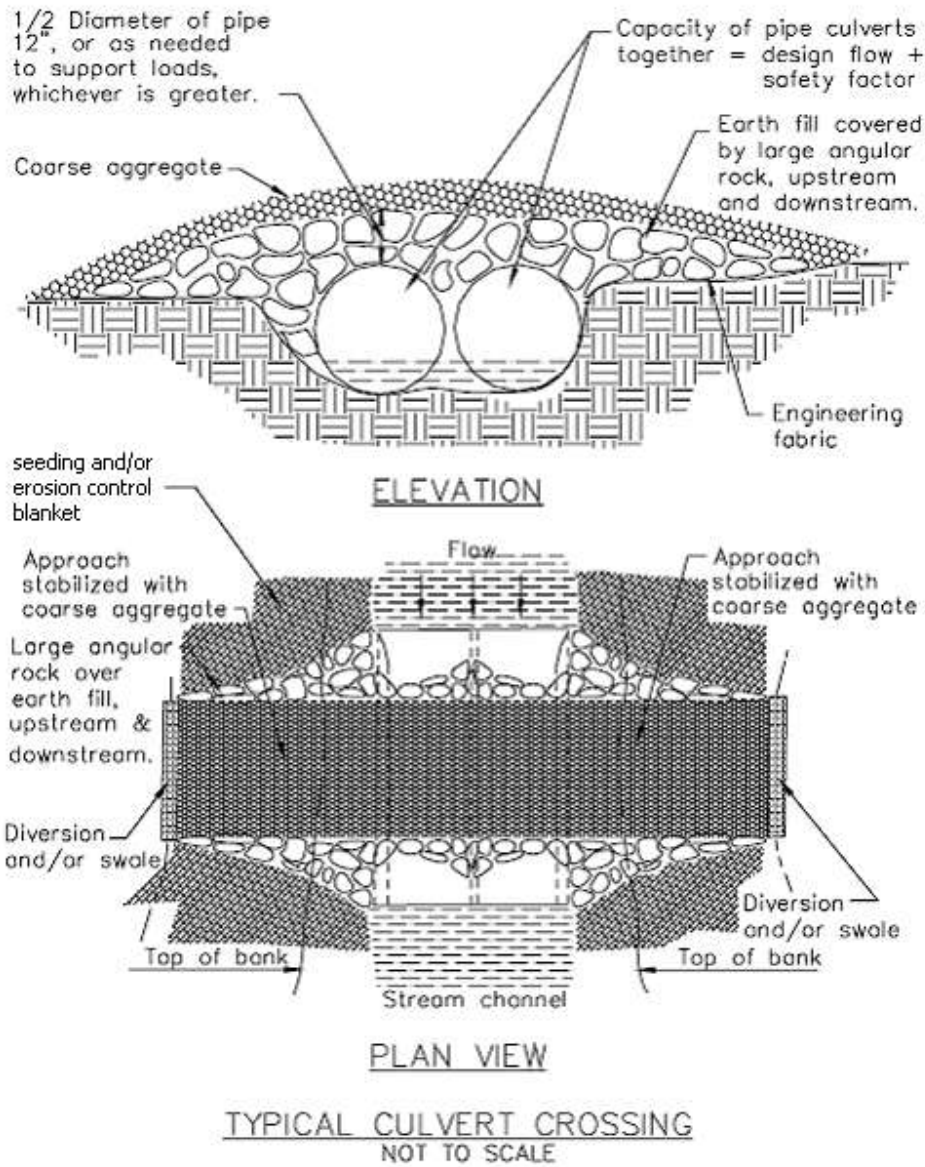
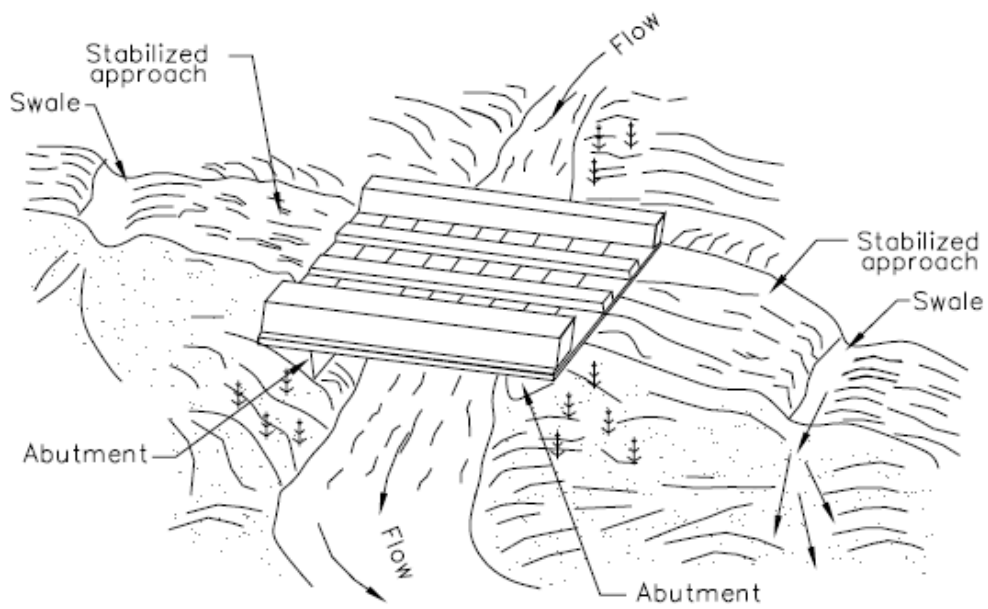

Figure C-26 Typical Temporary Culvert Crossing Schematic



NOTE:
 Surface flow of road diverted
 by swale and/or dike.

TYPICAL BRIDGE CROSSING
 NOT TO SCALE

Figure C-27 Typical Temporary Bridge Crossing Schematic

C.3.18 Concrete Washout Areas

The purpose of concrete washout areas is to prevent or reduce the discharge of pollutants to storm water from concrete waste by conducting washout offsite or performing onsite washout in a designated area, and training employees and subcontractors.

Application

A number of water quality parameters can be affected by the introduction of concrete, especially fresh concrete. Concrete affects the pH of runoff, causing significant chemical changes in water bodies and harming aquatic life.

Unacceptable Waste Concrete Disposal Practices

- Dumping in vacant areas on the job-site.
- Illicit dumping off-jobsite.
- Dumping into ditches or drainage facilities.

Approach

- Avoid unacceptable disposal practices listed above.
- Develop pre-determined, safe concrete disposal areas.
- Provide a washout area with a minimum of 6 cubic feet of containment area volume for every 10 cubic yards of concrete poured.
- Overflow of washdown water shall be discharged in an area protected by one or more sediment removal BMPs and shall be done in a manner that does not result in a violation of groundwater or surface water regulations.
- Incorporate requirements for concrete waste management into material supplier and subcontractor agreements.
- Do not wash out concrete trucks into storm drains, open ditches, streets, or streams.
- Perform washout of concrete trucks in designated areas only.
- Wash out wastes into the temporary pit where the concrete can set, be broken up, and then disposed properly.

Installation

Below grade concrete washout facilities are typical. These consist of a lined excavation sized to hold expected volume of washout material. Above grade facilities are used if excavation is not practical. Temporary concrete washout facility (type above grade) should be constructed with sufficient quantity and volume to contain all liquid and concrete waste generated by washout operations. Plastic lining material should be a minimum of 10 mil polyethylene sheeting and should be free of holes, tears, or other defects that compromise the impermeability of the material. See Figure C-28 for typical concrete washout areas.

Disposal

When temporary concrete washout facilities are no longer required for the work, the hardened concrete should be removed and disposed of. Materials used to construct temporary concrete washout facilities should be removed from the site of the work and disposed of. Holes, depressions or other ground disturbance caused by the removal of the temporary concrete washout facilities should be backfilled and repaired.

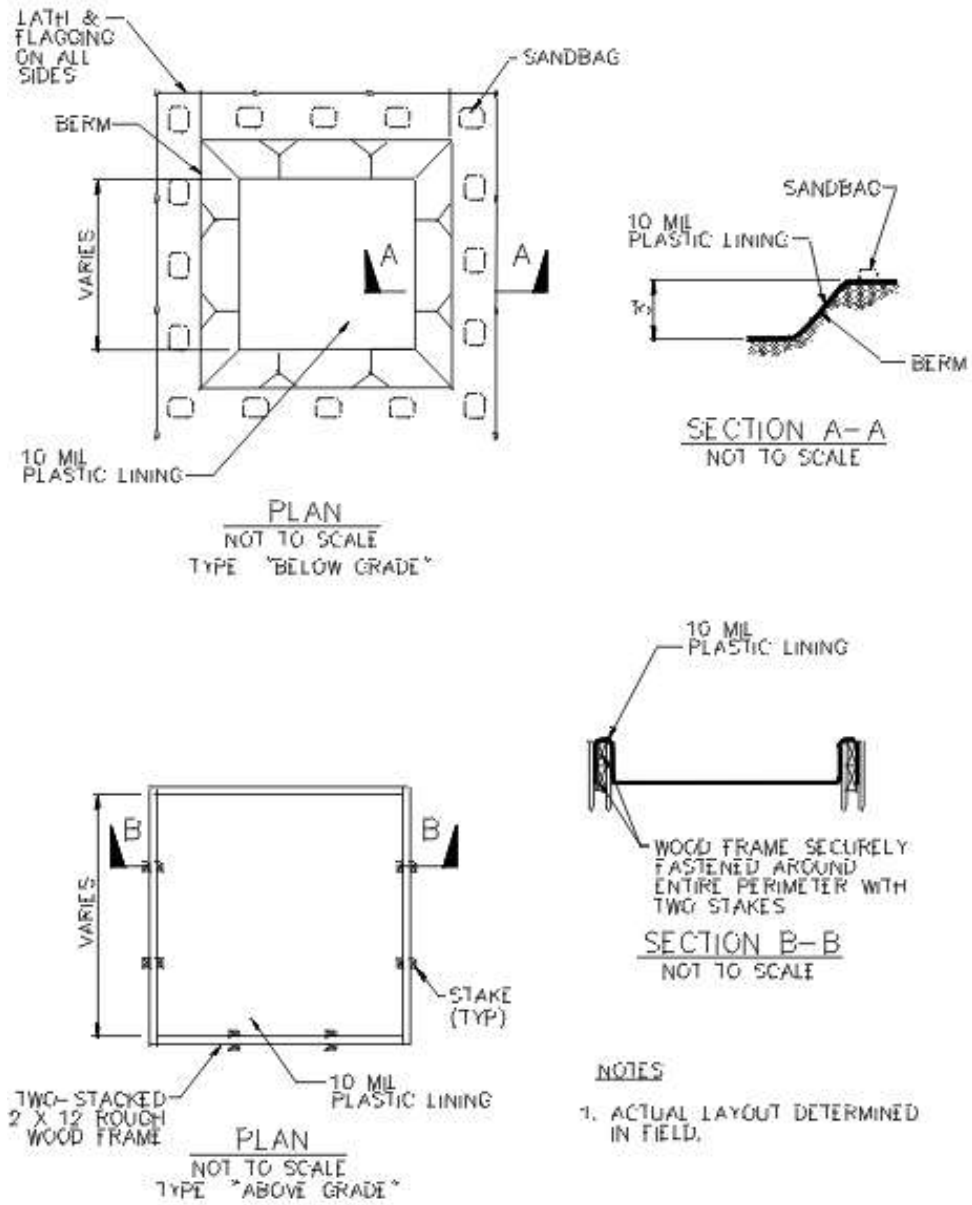

Figure C-28 Schematic Diagrams of Concrete Washout Areas